

OPERATIVE TECHNIQUE

PHOENIX™
Minimally Invasive Spinal Fixation System



 **ORTHOFIX®**

01	Pre-Operative Planning
01	▪ Patient Positioning
02	▪ Pedicle Identification and Incision Planning
04	Operative Technique
04	▪ Incision and Guide Wire Insertion
05	▪ Pedicle Preparation and Tissue Dilation
08	▪ Multi-Axial Screw Placement
10	▪ Rod Insertion
12	▪ Set Screw Insertion and Rod Reduction
14	▪ Compression/Distracton
15	▪ Final Tightening
15	▪ Tab Removal
	▪ Removal Procedure
16	Part Numbers
18	Implant Inserter Assembly and Disassembly
20	Indications for Use

The surgical technique shown is for illustrative purposes only. The technique(s) actually employed in each case will always depend upon the medical judgment of the surgeon exercised before and during surgery as to the best mode of treatment for each patient. Please see the Instructions For Use for the complete list of indications, warnings, precautions, and other important medical information.

1. PATIENT POSITIONING

Position the patient in the prone position. A/P and lateral fluoroscopy should be used to provide proper imaging. (Fig. 1)

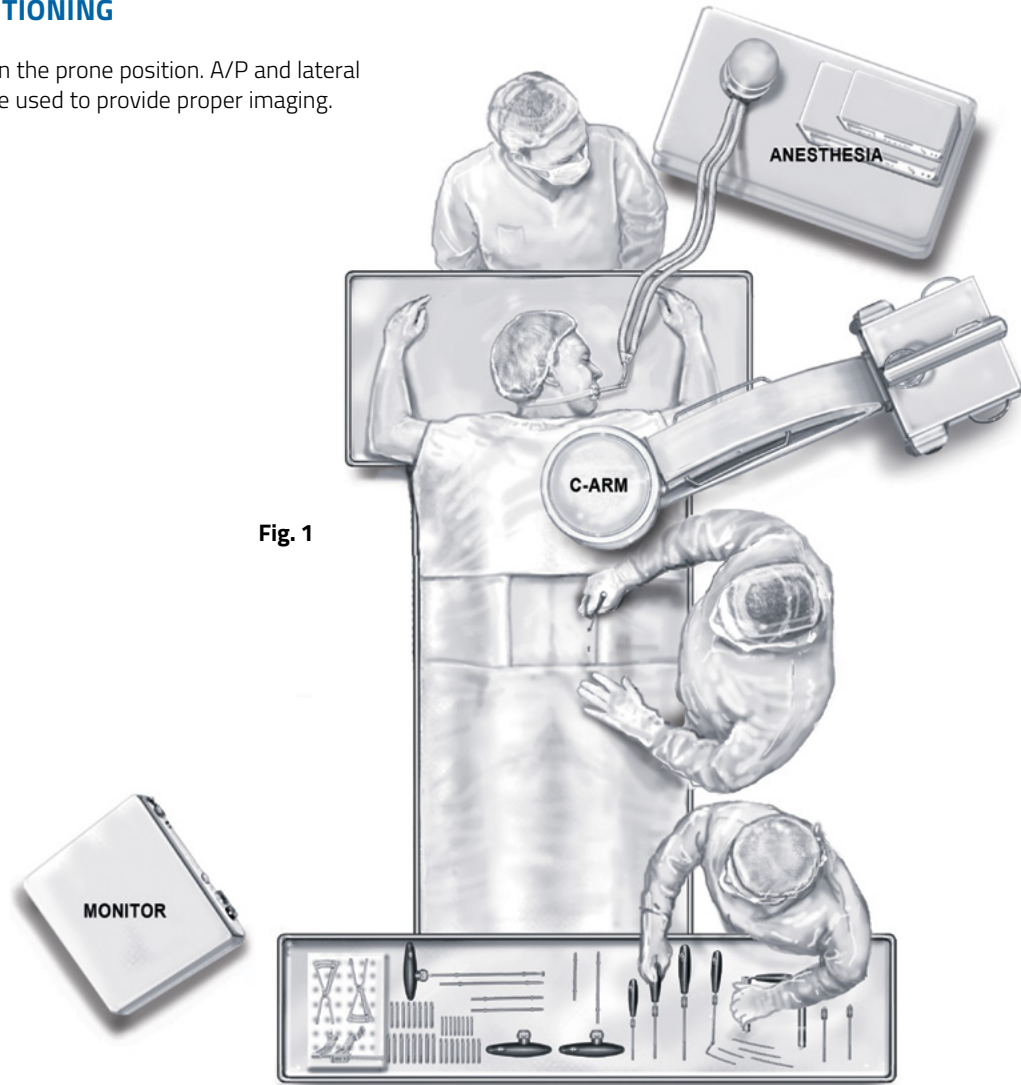

Fig. 1

2. PEDICLE IDENTIFICATION AND INCISION PLANNING

Attain an A/P fluoro with spinous process aligned and end plates parallel to each other. **(Fig. 2a)**

Verify the lateral edge of the pedicle ovals are close to the lateral edge of the vertebral body. **(Fig. 2b)** The top of the ovals for both pedicles should be parallel and equidistant from the end plate. **(Fig. 2c)**

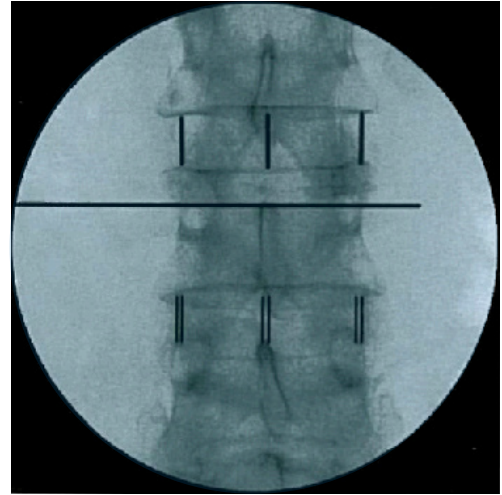

Fig. 2a

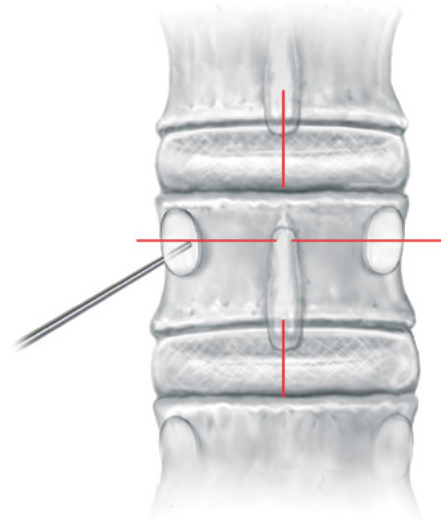

Fig. 2b

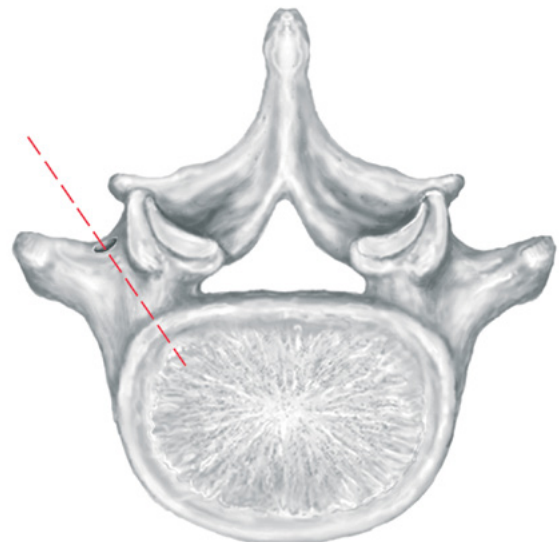
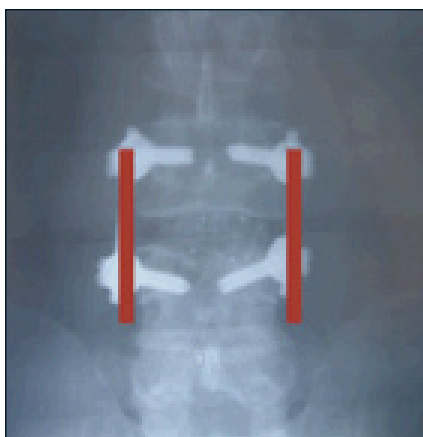
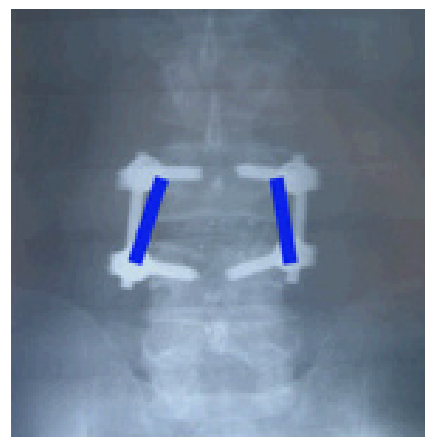

Fig. 2c

Incision placement will depend on the surgical approach and minimally invasive technique used to place the rod. The four figures provide common options when performing a single level fusion.



Incision for Mini on both sides using TLIF



Incision for Mini on both sides using PLIF

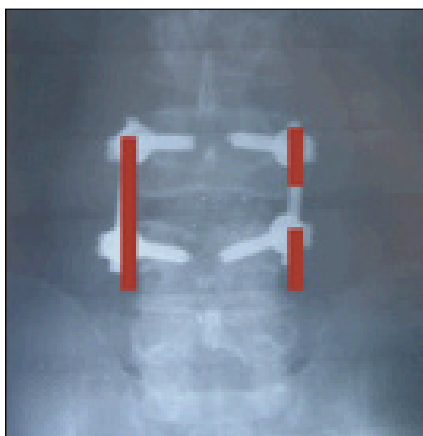

Incision for Mini on left side and percutaneous on right using TLIF

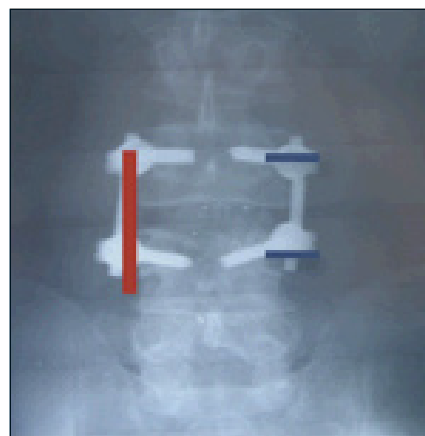

Incision for Mini on left side using TLIF and percutaneous on right

3. INCISION AND GUIDE WIRE INSERTION

Locate and make the first incision as defined in the incision planning step. The incision is approximately 14mm in length to match the diameter of the Phoenix Screw Body. **(Fig. 3a)**

Insert the Pedicle Targeting Needle into the pedicle entry point and advance under AP fluoro to ensure that the Pedicle Targeting Needle is not medial to the medial border of the pedicle prior to the entrance into the vertebral body. Multiple Pedicle Targeting Needles can be placed in succession prior to switching to lateral fluoro to check superior/inferior angulation. **(Fig. 3b)**

Remove the inner stylet of the pedicle targeting needle. Insert the Guide Wire (20-0123, 20-0124) through the Pedicle Targeting Needle and place the Guide Wire into the mid portion of the vertebral body on the lateral view. **(Fig. 3c)**

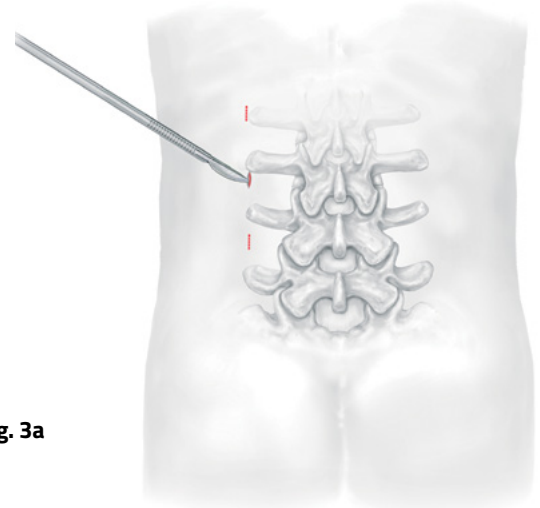

Fig. 3a

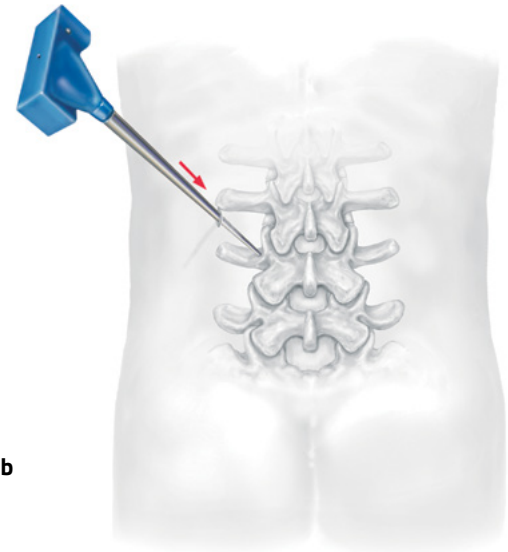

Fig. 3b

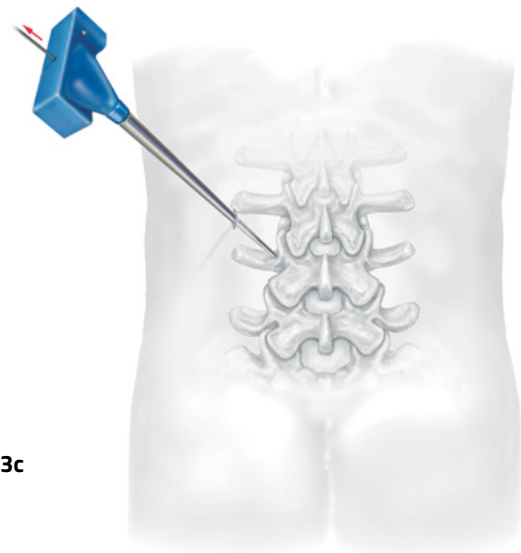

Fig. 3c

4. PEDICLE PREPARATION: TISSUE DILATION AND PEDICLE TAPPING

Assembly of Dilator/Awl/Tap Instrument

Choose the appropriate diameter Tap, 4.5, 5.5, 6.5 or 7.5mm (20-0145, 20-0155, 20-0165, 20-0175) based on surgeon preference and bone quality. Each Tap has a color band on the proximal end that corresponds the Tap diameter to the same color of the Screw. Assemble the T-Handle (52-1011) or a Straight Handle (52-1013) onto Tap. Next, assemble the Tap Sleeve Dilator (20-0275) onto the Tap until it lines up with the zero mark on the Tap. Advance the Tap Dilator until it engages the first groove on the Tap, this is your starting position for insertion into the incision. The Dilator will be retained in this position until the Release Button is depressed. A visual inspection is recommended to confirm the awl portion of the Tap thread is protruding through the tip of the Tap sleeve. **(Fig. 4a)**

NOTE: If pedicle screw monitoring is to be performed, there is a non-conductive dilator (20-0218) that should be placed over Dilator/Awl/Tap instrument prior to use.



Fig. 4a

4. PEDICLE PREPARATION: TISSUE DILATION AND PEDICLE TAPPING CONT.

Tissue Dilation

Place Tap with assembled Dilator over the Guide Wire (**Fig. 4b**) and advance through the tissue using a twisting motion.

(Fig. 4c) Once the Tap engages the bone, push the Release Button to allow the Tap Sleeve Dilator to move freely so the Awl and tapping can occur. **(Fig. 4d)**

The Tap Sleeve Dilator has measurements to indicate the appropriate length of Phoenix Screw Bodies to be used.

(Fig. 4e) Generally, the Short is used for the thoracic region and Standard and Long are used in the lumbar region based on patient size. Sometimes a longer size may be preferred in a longer construct to reach the anterolisthesed segment of a spondylolisthesis. It is ideal to have approximately 50% of the reduction head visible above the surface of the skin as indicated in the figure. **(Fig. 4e)**

A Non-Conductive Dilator (20-0218) can be placed on the Tap Sleeve Dilator if stimulation of the Tap is desired.

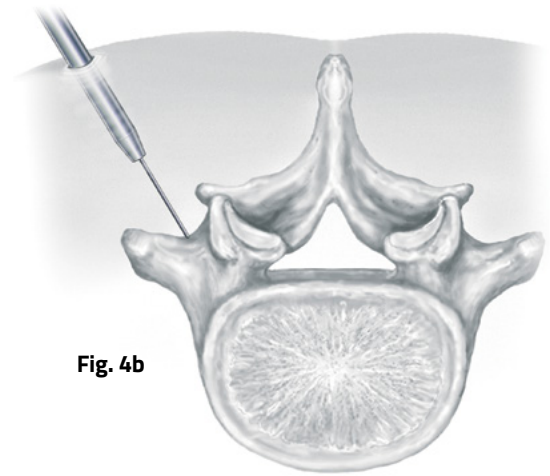

Fig. 4b

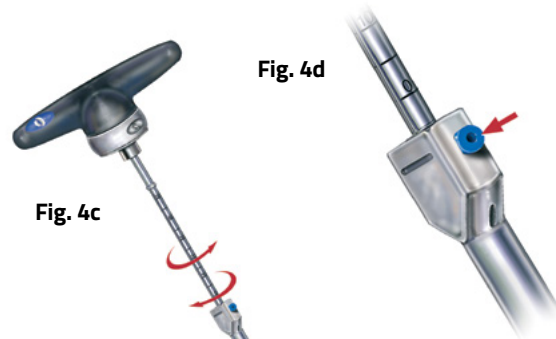

Fig. 4d

Fig. 4c

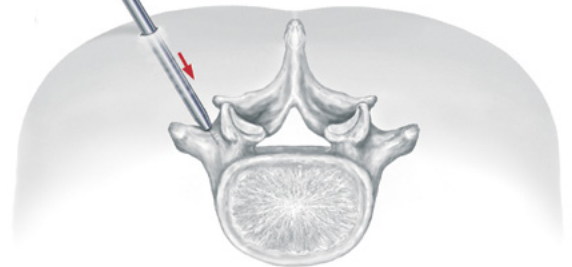

Fig. 4e

Awl

The instrument has a sharp tip design functioning as a Bone Awl to perforate the pedicle bone so tapping can occur. Use a clockwise twisting motion to break through the cortex. **(Fig. 4f)**

Tapping

Continue a clockwise motion for tapping the bone while maintaining a straight trajectory to avoid bending the tap. **(Fig. 4g)** Use periodic fluoroscopy to check on depth and proper alignment. When the Tap is at the desired depth, the screw length is measured by reading the scale on the Tap. **(Fig. 4h)** The Dilator must be in contact with the pedicle bone surface to achieve accurate measurement.

Remove the Tap Assembly leaving Guide Wire and Dilator (non-conductive) if desired behind.



Fig. 4f

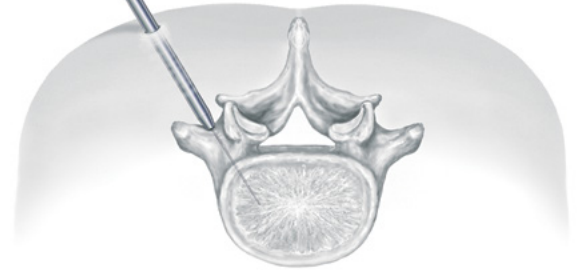

Fig. 4g

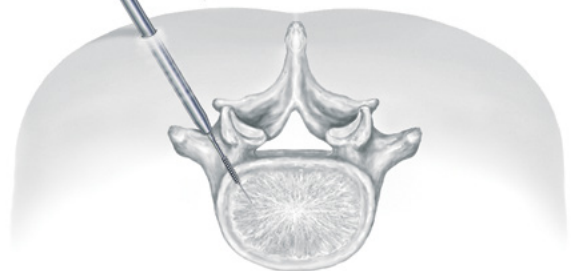
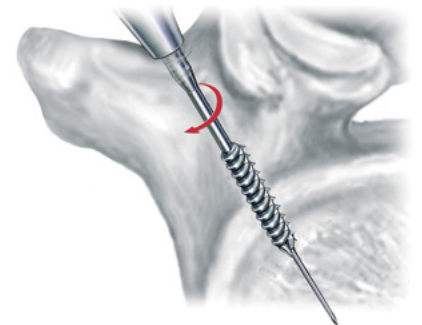
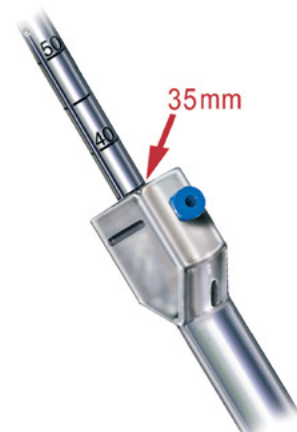

Fig. 4h



5. MULTI-AXIAL SCREW PLACEMENT

Implant Selection

There are two Phoenix Body styles to accommodate different rod passing techniques. **(Fig. 5a)** The closed (magenta) Phoenix Bodies are only used at the end of a construct and are optional based on surgeon preference. The closed style can also be used to guide the Rod into place for mini-open techniques.

The open (green) Phoenix Bodies are used in multi-level constructs and can also be used at the end of constructs based on surgeon preference.

See Step 4 – The Dilator has measurements to indicate the appropriate length of Phoenix Bodies to be used. Generally, the Short is used for thoracic region and Standard and Tall are used for lumbar based on patient size.

Sometimes a longer size may be preferred in a longer construct to reach the anterolisthesed segment of a spondylolisthesis.

It is ideal to have approximately 50% of the reduction head visible above the surface of the skin. **(Fig. 4e and 5b)**



Fig. 5a

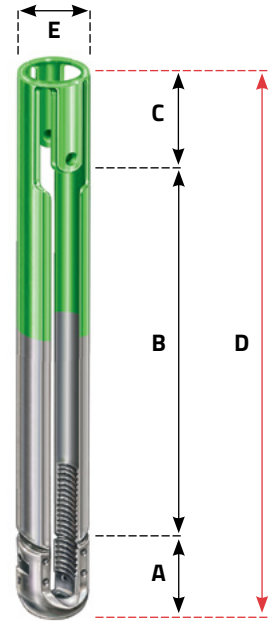

Fig. 5b

Phoenix Screw Body Styles	Dimension A Height of Saddle	Dimension B From Top of Saddle to Bottom of Tab	Dimension C Height of Tab	Dimension D Overall Phoenix Length	Dimension E Diameter
Short	16mm	70mm	18mm	104mm	14mm
Standard	16mm	90mm	18mm	124mm	14mm
Tall	16mm	120mm	18mm	154mm	14mm

Fig. 5b chart

Screw Driver Assembly

Attach the appropriate modular Phoenix Screw Body onto the desired Firebird® Modular Screw. Confirm a secure connection by pulling on the Screw.

Insert the Screwdriver (20-0200) with either the Straight Handle (52-1013) or the T-Handle (52-1011) into Phoenix Screw Body and engage the tip of the Screwdriver with square of the Modular Screw. **(Fig. 5c)** Rotate the knob on a Screwdriver in a clockwise direction to assemble the Head of the Screw onto the Screwdriver Tip. **(Fig. 5d)** Confirm the Screw is solidly attached to the Screwdriver and do not overtighten.

Using the Screwdriver, drive the Multi-Axial Screw of appropriate length over the Guide Wire into the prepared Pedicle. Remove the Guide Wire after the Screw enters the vertebral body. **(Fig. 5e)** Periodically check with fluoro to ensure proper Screw placement based on surgeon preference. Over-insertion of Screw may limit poly-axial motion of the Reduction Head. Once the Screw is seated to the appropriate level, turn the Knob in a counter-clockwise direction and remove the Screwdriver. **(Fig. 5d)**

NOTE: If for any reason the Phoenix Screw needs to be adjusted after the Screwdriver is removed, there is modular Multi-Axial Adjustment Screw Driver (20-0201) that mates with the Straight Handle (52-1013) to easily advance or withdraw the Screw.

Place the remaining Screws using the same technique by repeating Steps 3 to 5.

NOTE: Preparation of disc space may occur before or after Screw placement based on surgeon preference.

NOTE: Optional sterile packed HA coated bone screws are available upon request.



Fig. 5c

Fig. 5d

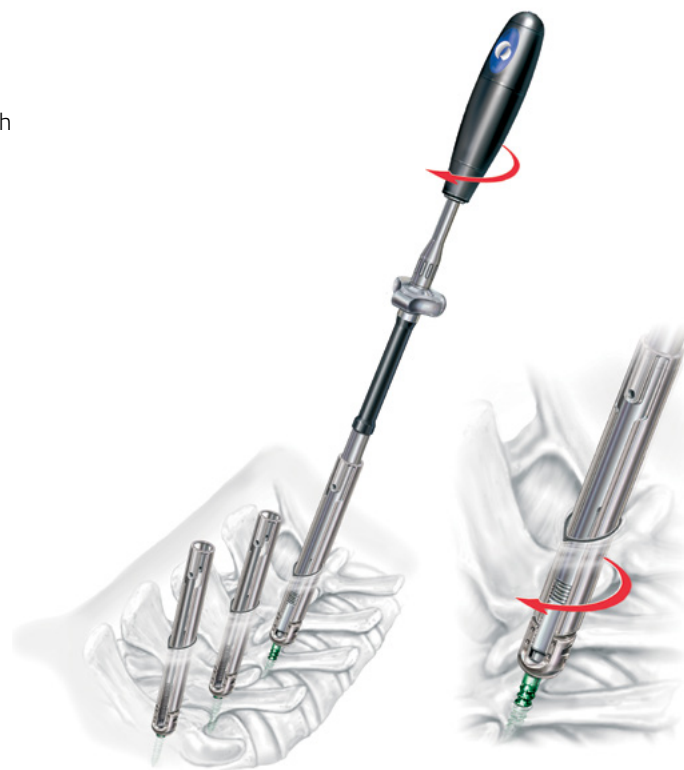

Fig. 5e

6. ROD INSERTION – ROD LENGTH

Determination

The Rod Sizing Tool (20-0205) is inserted into the most proximal and distal Phoenix Screw Body and the reading is taken from the markings on the scale. **(Fig. 6a)** This is a direct measurement and no additional numeric addition is necessary to determine proper length. Example: if the measurement tool reads 100mm, then select a 100mm Lordotic or Straight Hex Rod. Both ends of the Caliper must be inserted until they contact the screw head to ensure an accurate measurement. This technique works up to a maximum of 150mm. The option exists to cut and bend Rods as required.

WARNING: Excessive or repeated bending of rods may reduce strength and result in construct failure.

Rod Inserter Assembly

Align the Hex end of the Rod with the Hex mating features of the Rod Holder (20-0214). Attach rod to holder to allow for insertion while maintaining the desired curvature of the rod. Firmly push the Hex into the Rod Inserter until it is fully seated. **(Fig. 6b)** Rotate the knob on the Inserter in a clockwise motion to draw the Rod upwards until the front surface of the tip aligns and is engaged in the undercut feature of the Rod. **(Fig. 6c)** This will prevent the Rod from becoming disengaged during insertion.

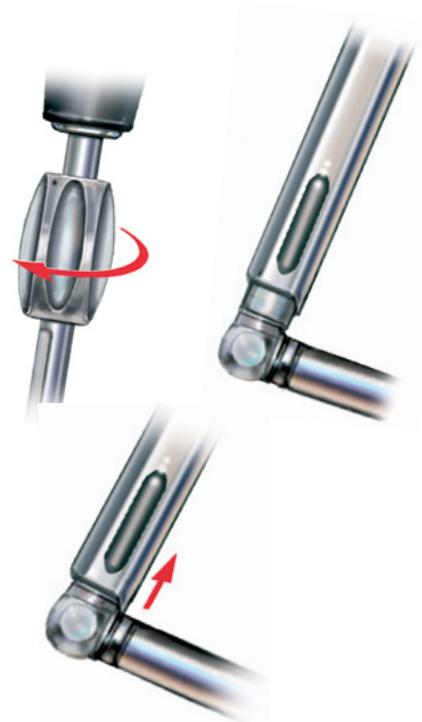

Fig. 6a



Fig. 6b

Fig. 6c



Option: Creating a Tunnel for Rod

The Tissue Dissector (20-0283) may be used to create a tunnel for passing the Rod into position. The distal tip of the Tissue Dissector is passed through the end of the construct with the hook facing up away from the spine. **(Fig. 6d)**

Advance the instrument through each Phoenix Screw Saddle until it passes to the opposite end of the construct. Slowly pull the instrument back which will dissect the tissue with distal hook of the instrument.

Percutaneous Rod Passing

This technique requires use of the open body for the end of the construct where the Rod is to be introduced. Align the openings of the Phoenix Bodies by hand to facilitate easy passing of the Rod. A Body Alignment Tool (20-0212) is available to align the openings if tissue or bone prevents positioning by hand. The leading tapered end of the Rod is passed through the open channel in the Phoenix Screw Body until it passes below the fascia and into the Screw Head. The Rod Inserter handle will be almost parallel to the patient during this phase of Rod passage. **(Fig. 6e)**

When distal tip of Rod enters the Screw Head, begin to rotate the Rod Inserter handle which will push the Rod through to the adjacent levels. Once the Rod is seated, the Rod Inserter handle will be approximately perpendicular to the patient. **(Fig. 6f)**

Excessive forces should not be required to pass the Rod through the tissue. If Rod passage is difficult, remove the Rod Inserter and utilize the tissue dissector **(Fig. 6d)**. The Rod Pusher (20-0210) can be inserted down the Phoenix Screw Body to seat the Rod into position. **(Fig. 6g)**

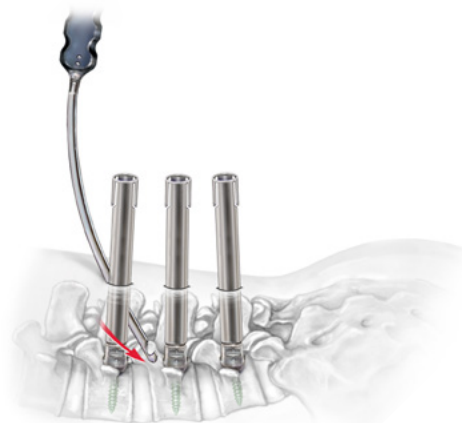

Fig. 6d

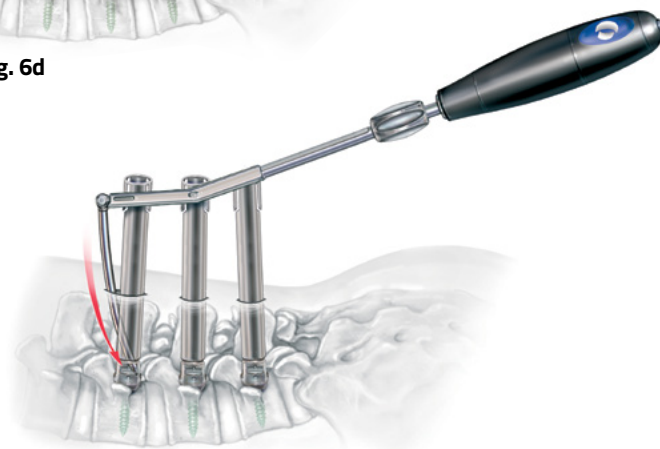

Fig. 6e



Fig. 6f

Fig. 6g

ALTERNATIVE - HOOK ROD INSERTER

Hook Rod Inserter (70-3208) can be used in mini-open procedures by attaching the hook to the rod, and dropping down between Phoenix Bodies. (**Fig. 6h**)

7. SET SCREW INSERTION AND ROD REDUCTION

The Rod is brought into correct position and is stabilized with Rod Holder. The Set Screws are assembled onto the Set Screw Holders (20-0250, 20-0260) and held in place by depressing the button on the top of the handle. The Set Screws are inserted into each Phoenix Screw Body and are used to seat the Rod into the Impant Saddle. The Set Screw is fully seated when the Set Screw Holder's corresponding laser mark (Short, Standard, Tall) reaches the top of the Screw Body. (**Fig. 7a**)

The instrument set contains two long Set Screw Holders and one short Set Screw Holder. The two different lengths of Inserters allow for simultaneous tightening of the Set Screws in tight working spaces as shown in figure. The round handle design eliminates the issues with the interference of using T-Handles side-by-side. A/P and lateral fluoroscopic views can be used to ensure proper Rod positioning and the extent of reduction. (**Fig. 7b**) There are two Round Handles (20-0211) that can be placed on the existing set screw handle, if a larger grip surface is desired. They can also be used to provide greater force when reducing a spondylolisthesis.

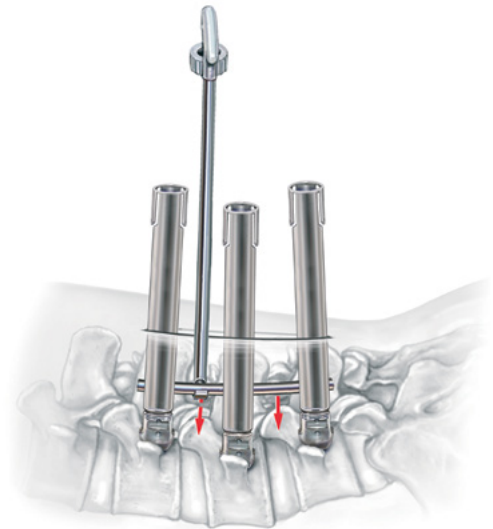

Fig. 6h



Fig. 7a



Fig. 7b

7b. ALTERNATIVE STEP FOR TREATMENT OF SPONDYLOLISTHESIS: SET SCREW INSERTION AND ROD REDUCTION

The built-in reduction capability is also useful for reducing a spondylolisthesis by first provisionally tightening one Set Screw followed by tightening of the anterolisthesed segment to establish deformity correction.

Fully seat the set screws in the Phoenix Screw Bodies on either side of the vertebrae with the spondylolisthesis. Then insert the Set Screw on the vertebrae with spondylolisthesis. **(Fig. 7c)**

Advancing the Screw provides the reduction force to align the vertebrae. Make sure the black lines on the set screw holder shaft indicate the set screw is fully seated. **(Fig. 7d)** There are two Round Handles (20-0211) that can be placed on the existing set screw handle, if a larger grip surface is desired. They can also be used to provide greater force when reducing a spondylolisthesis.

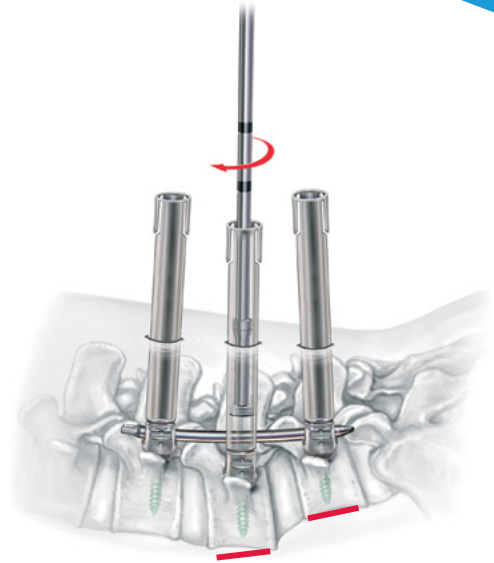

Fig. 7c

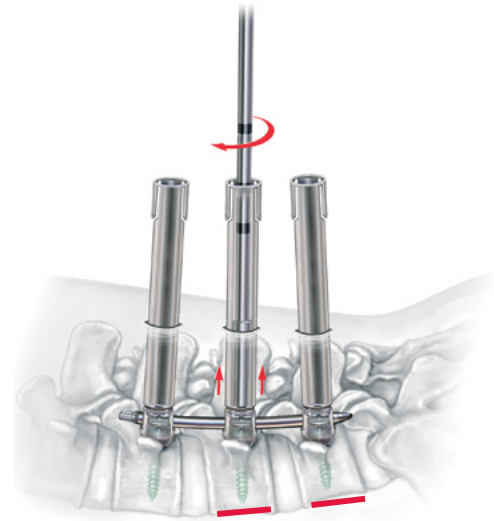
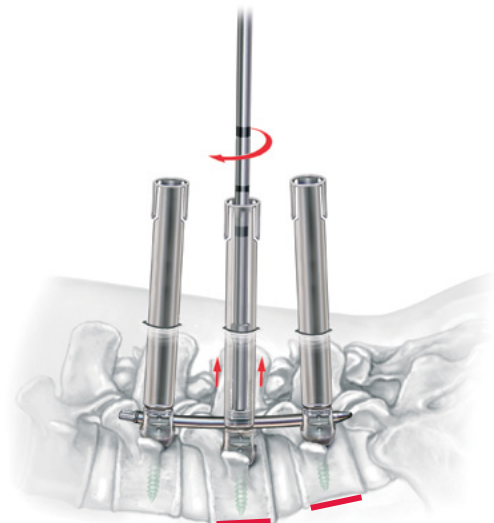

Fig. 7d



8. COMPRESSION/DISTRACTION

Compression

Slide the Torque Wrench Cannulas (20-0226) over each Phoenix Screw Body to which you are going to apply compression forces. Application of compression forces without use of the cannulas is not recommended. The slot in the end of the Cannula is aligned and engages the rod. Slide the Alignment Tool (70-3221) over the top of the cannulas and draw the cannulas together with either upward or downward force on the handle of the alignment tool. Alternative method – The compression/distraction fixture (20-0220) can be used in place of the alignment tool (70-3221). Adjust the fixture to the desired width and lock the adjustment nut on the fixture.

Attach the compression instrument (70-3218) to the holes in the cannulas closest to the level of the skin. Compress the Cannulas to the desired level and proceed to final tightening of Set Screws. **(Fig. 8a)**

Distraction

Slide the Torque Wrench Cannulas (20-0226) over each Phoenix Screw Body to which you are going to apply distraction forces. Application of distraction forces without use of the cannulas is not recommended. The slot in the end of the Cannula is aligned and engages the rod. Slide the compression/distraction fixture (20-0220) over the top of the cannulas. Adjust the fixture to the desired width and lock the adjustment nut on the fixture. Assemble the distraction tips (left 70-3220 & right 70-3222) on distraction instrument (70-3219) and attach to the holes in the cannulas closest to the level of the skin. Distract the Cannulas to the desired level and proceed to final tightening of set screws. **(Fig. 8b)**

Compression

Fig. 8a

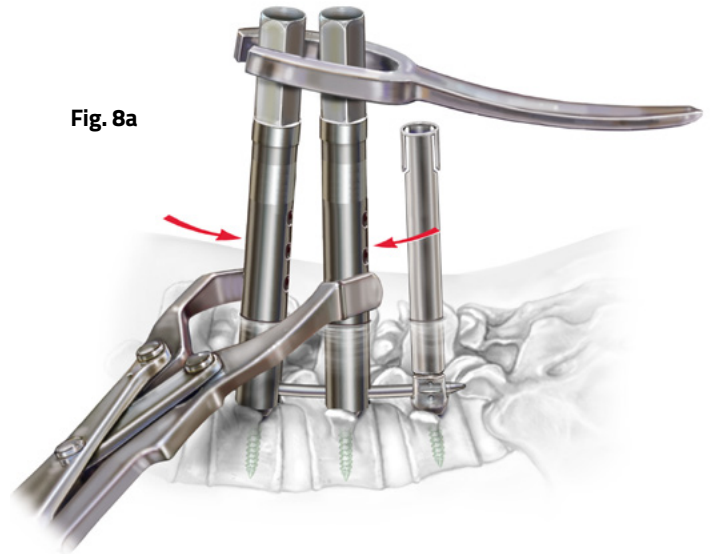

Distraction

Fig. 8b

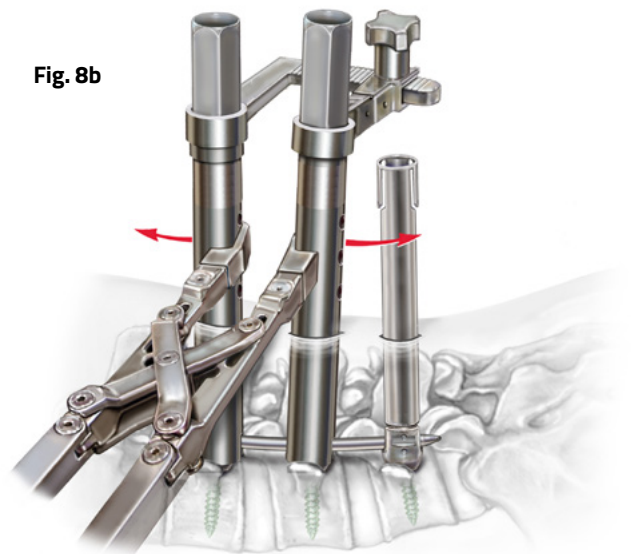

9. FINAL TIGHTENING

The Torque Wrench Cannula slides over the Phoenix Screw Body and has two distal openings to engage the Rod. The Counter Torque Wrench Handle (20-0225) slides over the hex end of the Cannula. The Torque T-Handle (52-1512) attached to the Set Screw Driver (52-1061) is passed down the Phoenix Screw Body and mates with the Set Screw. **ALTERNATIVE – When the use of compression or Distraction is not desired, then a one piece Counter Torque Wrench (20-0224) can be used in place of the modular instruments.** Turn the Torque T-Handle (55-1068) clockwise to tighten the Set Screw to 100 in/lbs. The handle will reach its maximum torque and release at 100 in/lbs. (Fig. 9)



Fig. 9

10. TAB REMOVAL

Position the three claws on the small end of the Implant Tab Removal Tool (20-0280) below one of the small tabs on the Phoenix Screw Body and use an upward motion to engage the claws of the tool onto the tab. Rotate the handle downward causing the small end to rotate up and the small tab will break free of the Phoenix Screw Body. Perform the same steps on the opposite side. (Fig. 10a) The small tabs can be discarded or recycled.

Slide the large opening of the Implant Tab Removal tool over the large tab on one side of the Phoenix Screw. Move the handle away from the midline and then back to midline until the large tab dissociates from the Phoenix Screw Head. Perform the same steps on the remaining tab. (Fig. 10b) The larger tabs can be discarded or recycled.

Fig. 10a



11. REMOVAL PROCEDURE

Removal of implants should be performed as outlined in the Firebird Spinal Fixation Operative Technique.

Fig. 10b



PHOENIX IMPLANT CASE, 20-0017

Part Numbers

Part #	Description	Qty
--------	-------------	-----

Phoenix Implant Case

20-0111	Implant Case (Empty)	1
----------------	----------------------	---

Phoenix Bodies

20-2070	Phoenix™ Open Body, Short	18
20-2090	Phoenix™ Open Body, Standard	18
20-2120	Phoenix™ Open Body, Tall	18
20-3070	Phoenix™ Closed Body, Short	*
20-3090	Phoenix™ Closed Body, Standard	*
20-3120	Phoenix™ Closed Body, Tall	*

Firebird Set Screws

44-2001	Set Screw	30
----------------	-----------	----

Firebird Cannulated Modular Screw/Self Tapping

77-8420	4.5mm / 20mm	*
77-8425	4.5mm / 25mm	*
77-8430	4.5mm / 30mm	*
77-8435	4.5mm / 35mm	*
77-8440	4.5mm / 40mm	*
77-8445	4.5mm / 45mm	*
77-8450	4.5mm / 50mm	*
77-8455	4.5mm / 55mm	*
77-8535	5.5mm / 35mm	6
77-8540	5.5mm / 40mm	8
77-8545	5.5mm / 45mm	8
77-8550	5.5mm / 50mm	6
77-8555	5.5mm / 55mm	4
77-8635	6.5mm / 35mm	4
77-8640	6.5mm / 40mm	10
77-8645	6.5mm / 45mm	12
77-8650	6.5mm / 50mm	10
77-8655	6.5mm / 55mm	4
77-8740	7.5mm / 40mm	4
77-8745	7.5mm / 45mm	6
77-8750	7.5mm / 50mm	6
77-8755	7.5mm / 55mm	4
77-8840	8.5mm / 40mm	2
77-8845	8.5mm / 45mm	2

* By Request Only, Not Standard in Set

Part Numbers

Part #	Description	Qty
--------	-------------	-----

Firebird Lordotic Rods with Hex

20-4035	Pre-Lordosed Rod w/hex and taper, 35mm	4
20-4040	Pre-Lordosed Rod w/hex and taper, 40mm	4
20-4045	Pre-Lordosed Rod w/hex and taper, 45mm	4
20-4050	Pre-Lordosed Rod w/hex and taper, 50mm	4
20-4055	Pre-Lordosed Rod w/hex and taper, 55mm	4
20-4060	Pre-Lordosed Rod w/hex and taper, 60mm	4
20-4065	Pre-Lordosed Rod w/hex and taper, 65mm	4
20-4070	Pre-Lordosed Rod w/hex and taper, 70mm	4
20-4075	Pre-Lordosed Rod w/hex and taper, 75mm	4
20-4080	Pre-Lordosed Rod w/hex and taper, 80mm	4
20-4090	Pre-Lordosed Rod w/hex and taper, 90mm	4
20-4100	Pre-Lordosed Rod w/hex and taper, 100mm	4
20-4110	Pre-Lordosed Rod w/hex and taper, 110mm	4
20-4120	Pre-Lordosed Rod w/hex and taper, 120mm	4
20-4130	Pre-Lordosed Rod w/hex and taper, 130mm	4
20-4140	Pre-Lordosed Rod w/hex and taper, 140mm	4
20-4150	Pre-Lordosed Rod w/hex and taper, 150mm	4

Phoenix Straight Rods with Hex

20-5040	Straight Rod w/hex and taper, 40mm	2
20-5050	Straight Rod w/hex and taper, 50mm	2
20-5060	Straight Rod w/hex and taper, 60mm	2
20-5070	Straight Rod w/hex and taper, 70mm	2
20-5080	Straight Rod w/hex and taper, 80mm	2
20-5090	Straight Rod w/hex and taper, 90mm	2
20-5100	Straight Rod w/hex and taper, 100mm	2
20-5110	Straight Rod w/hex and taper, 110mm	2
20-5120	Straight Rod w/hex and taper, 120mm	2
20-5140	Straight Rod w/hex and taper, 140mm	2
20-5160	Straight Rod w/hex and taper, 160mm	2
20-5180	Straight Rod w/hex and taper, 180mm	2
20-5200	Straight Rod w/hex and taper, 200mm	2
20-5450	Straight Rod w/hex, 450mm	2

PHOENIX INSTRUMENT CASE 1, 20-0015

INSTRUMENTS

Part #	Description	Qty
20-0101	Instrument Case 1 (Empty)	1
20-0123	Guide Wire Nitinol, 21 inch - Blunt (1.57mm Dia)	10
20-0124	Guide Wire Nitinol, 21 inch - Sharp (1.57mm Dia)	10
20-0145	4.5mm Tap	*
20-0155	5.5mm Tap	1
20-0165	6.5mm Tap	1
20-0175	7.5mm Tap	1
20-0200	Screw Driver	2
20-0201	Modular Multi-axial Adjustment Screw Driver	1
20-0205	Rod Sizing Tool	1
20-0210	Rod Pusher	1
20-0211	Round Set Screw Inserter Handle	2
20-0212	Body Alignment Instrument	1
20-0214	Rod Holder/Inserter	1
20-0218	Non-Conductive Dilator	2
20-0224	Counter Torque Wrench	1
20-0250	Set Screw Holder Long	2
20-0251	Set Screw Holder Long Insert	2
20-0260	Set Screw Holder Short	1
20-0261	Set Screw Holder Short Insert	1
20-0275	Tap Sleeve Dilator	2
20-0280	Implant Tab Removal Tool	1
20-0283	Tissue Dissector	1
52-1011	Cannulated Firebird T-handle	2
52-1013	Straight Ratcheting Handle, Small	2
52-1061	Set Screw Driver (adapter)	2
70-3208	Proview Rod Inserter	1

* By Request Only, Not Standard in Set

PHOENIX INSTRUMENT CASE 2, 20-0016

INSTRUMENTS

Part #	Description	Qty
20-0120	Instrument Case 2 (Empty)	1
20-0220	Compression/Distractor Fixture	1
20-0225	Counter Torque Wrench Handle	1
20-0226	Counter Torque Cannula	2
52-1512	Torque T-Handle	1
70-3218	Parallel Compressor	1
70-3219	Parallel Distractor	1
70-3220	Distractor Tip Left	1
70-3221	Alignment Tool	1
70-3222	Distractor Tip Right	1

OTHER INSTRUMENTS

Part #	Description	Qty
21-5000	Bone Marrow Aspiration Needle Kit, 8 gauge	1
21-5011	Bone Marrow Aspiration Needle Kit, 11 gauge	1

Instructions for Assembly/Disassembly of the Multi-Axial Screw Driver (20-0200)

There are three parts to the Multi-Axial Screw Driver: **1) Inner Shaft**, **2) Screwdriver Shaft**, and **3) Extender Shaft**.



The Multi-Axial Screw Driver requires disassembly prior to cleaning using the following steps.

Assembly/Inspection of the Multi-Axial Screw Driver (20-0200)

- Insert inner shaft completely into screwdriver shaft. Large end of inner shaft should be on the same side as the threaded tip of screwdriver shaft. If not, reverse inner shaft insertion. **(Fig. 1 & 2)**
- While holding inner shaft and screwdriver shaft in place, align D-cut on inner shaft with D-shaped hole on extender shaft. **(Fig. 3)**
- With slotted knob on the extender shaft pulled back (away from threads), slide extender shaft and inner shaft together until it clicks. **(Fig. 4 & 5)**
- Push slotted knob on extender shaft forward and turn until threads are fully engaged. **(Fig. 6)**
- After assembly, ensure that turning extender shaft smoothly rotates inner shaft within the screwdriver. **(Fig. 7)**
- If inner shaft does not rotate smoothly or extender shaft knob will not fully seat, disassemble instrument and check for debris.
- If debris is found, repeat cleaning and attempt assembly.



(Fig. 1)



(Fig. 2)

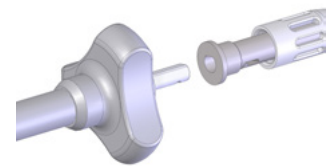

(Fig. 3)

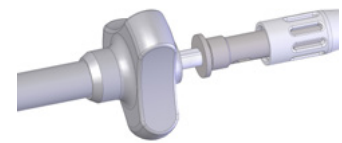

(Fig. 4)

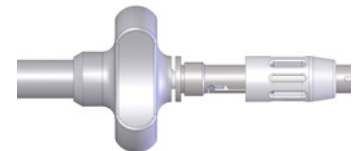

(Fig. 5)

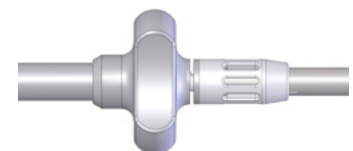

(Fig. 6)

Disassembly of the Multi-Axial Screw Driver (20-0200)

- Turn slotted knob at back of screwdriver until knob completely unthreads. **(Fig. 5)**
- Slide slotted knob back to the stop on extender shaft. **(Fig. 4)**
- Remove extender shaft from inner shaft by pulling axially until extender shaft is free. **(Fig. 3)**
- Pull inner shaft out of screwdriver shaft. **(Fig. 1)**



(Fig. 7)

Once disassembly is complete there will be three parts to the Multi-Axial Screw Driver. **Note:** To avoid components falling, it is suggested to hold the assembly horizontal and/or perform the assembly over a table.

Instructions for Assembly/Disassembly of the Mono-Axial Screw Driver (20-0300)

There are three parts to the Mono-Axial Screw Driver: **1**) Drive Adapter, **2**) Sleeve Assembly, and **3**) Handle Adapter.



The Mono-Axial Screw Driver requires disassembly prior to cleaning using the following steps..

Assembly/Inspection of the Mono-Axial Screw Driver (20-0300)

- Insert drive adapter completely into sleeve assembly. Large end of drive adapter should be on the opposite side of the knob of the sleeve assembly. If not, reverse drive adapter insertion. **(Fig. 1 & 2)**
- While holding drive adapter in place, align D-cut on drive adapter with D-shaped hole on handle adapter. **(Fig. 3 & 4)**
- With knob on the handle adapter loosened (away from threads), slide handle adapter and drive adapter together until it clicks. **(Fig. 5)**
- Push knob on handle adapter forward and turn until threads are fully engaged. **(Fig. 6 & 7)**
- After assembly, ensure that turning handle adapter smoothly rotates drive adapter within the screw driver.
- If drive adapter does not rotate smoothly or handle adapter knob will not fully seat, disassemble instrument and check for debris.
- If debris is found, repeat cleaning and attempt assembly.



(Fig. 1)



(Fig. 2)

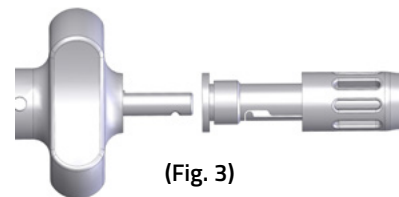

(Fig. 3)

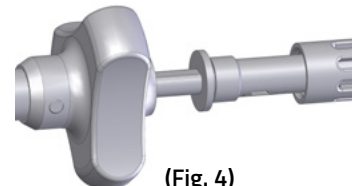

(Fig. 4)

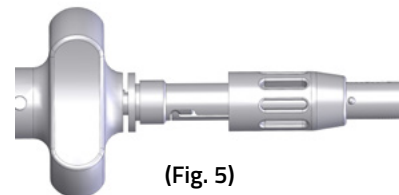

(Fig. 5)

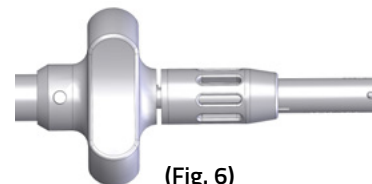

(Fig. 6)



(Fig. 7)

Disassembly of the Multi-Axial Screw Driver (20-0300)

- Turn knob on handle adapter until knob completely unthreads. **(Fig. 5)**
- Remove handle adapter from drive adapter by pulling axially until handle adapter is free. **(Fig. 3)**
- Pull drive adapter out of sleeve assembly. **(Fig. 1)**

Once disassembly is complete there will be three parts to the Mono-Axial Screw Driver. **Note:** To avoid components falling, it is suggested to hold the assembly horizontal and/or perform the assembly over a table.

Please refer to the product "Instructions for Use" for full information on indications for use, contraindications, warnings, precautions and adverse reactions at orthofix.com/IFU

Distributed by:

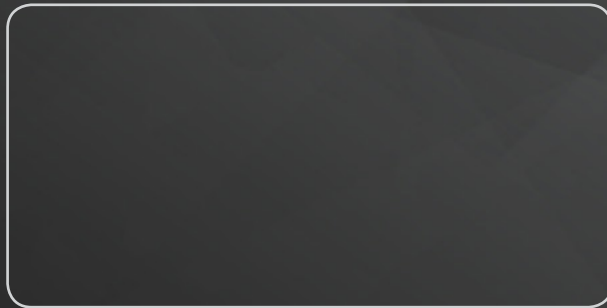

Proper surgical procedure is the responsibility of the medical professional. Operative techniques are furnished as an informative guideline. Each surgeon must evaluate the appropriateness of a technique based on his or her personal medical credentials and experience.

CE 0086



Manufactured by:
Orthofix
3451 Plano Parkway
Lewisville, Texas 75056-9453 USA
214-937-2000



Medical Device Safety Services (MDSS):
Schiffgraben 41
30175, Hannover
Germany
+49 511 6262 8630

RX Only