

OPERATIVE TECHNIQUE



FIREBIRD[®]
DEFORMITY CORRECTION SYSTEM



 **ORTHOFIX[®]**



01	Introduction
02	Thoracic Fixation
12	Iliac Fixation
17	Hook Fixation
22	Implant/Instrument Catalog

The surgical technique shown is for illustrative purposes only. The technique(s) actually employed in each case will always depend upon the medical judgment of the surgeon exercised before and during surgery as to the best mode of treatment for each patient. Please see the Instructions For Use for the complete list of indications, warnings, precautions, and other important medical information.

INTRODUCTION

As an extension to the already versatile Firebird® Spinal Fixation System platform, the Firebird Deformity Correction System offers even greater options for surgeons treating patients with spinal deformity. When surgically treating a variety of thoracolumbar

and sacral pathologies, the Firebird Deformity Correction System offers additional implant and instrument options to the Firebird Spinal Fixation System needed to perform complex spine procedures.

SYSTEM FEATURES

Thoracic Fixation

Uniplanar Screws

- Work in conjunction with Direct Vertebral Rotation instruments for rotation procedures
- Facilitate rod placement in kyphotic deformities
- 4.0mm, 4.5mm, 5.5mm and 6.5mm diameters
- Available in reduction style

Reduction and Rotation Instrumentation

- Linear Rod Reducer and Tubular Rod Reducer
- Direct Vertebral Rotation instrument construct that is easy to use as well as to assemble and disassemble

Iliac Fixation

- Modular bone screw capability provides more connector options
- Large bone screws are available to aid in iliac fixation
- Traditional Mono-Axial Lateral Offsets
- Low Profile Offset for use with modular bone screws

Hook Fixation

- Angled Hooks (left and right)
- Laminar Hooks (narrow and wide)
- Offset Hooks (left and right)
- Pedicle Hooks (small, medium and large)
- Thoracic Hooks (narrow and wide)



Thoracic Fixation Operative Technique

The Firebird Thoracic Fixation module provides the necessary instruments and implants for thoracic pedicle fixation as well as those needed for rod reduction, rod and vertebral body rotation, and thoracic deformity correction.

1. THORACIC PEDICLE SCREW STARTING POINTS

Use Mono-Axial Screws, Uniplanar Screws, or Multi-Axial Screws for the straightforward approach indicated by the redlines. Use Multi-Axial Screws and Uniplanar Screws only for the anatomic approach indicated by the blue lines. (Fig. 1)

Level	Cephalad-Caudad Starting Point	Medial-Lateral Starting Point
T1	Midpoint TP	Junction: TP-Lamina
T2	Midpoint TP	Junction: TP-Lamina
T3	Midpoint TP	Junction: TP-Lamina
T4	Junction: Proximal Third-Midpoint TP	Junction: TP-Lamina
T5	Proximal Third TP	Junction: TP-Lamina
T6	Junction: Proximal Edge-Proximal Third TP	Junction: TP-Lamina-Facet
T7	Proximal TP	Midpoint Facet
T8	Proximal TP	Midpoint Facet
T9	Proximal TP	Midpoint Facet
T10	Junction: Proximal Edge-Proximal Third TP	Junction: TP-Lamina-Facet
T11	Proximal Third TP	Just medial to lateral pars
T12	Midpoint TP	At the level of lateral pars

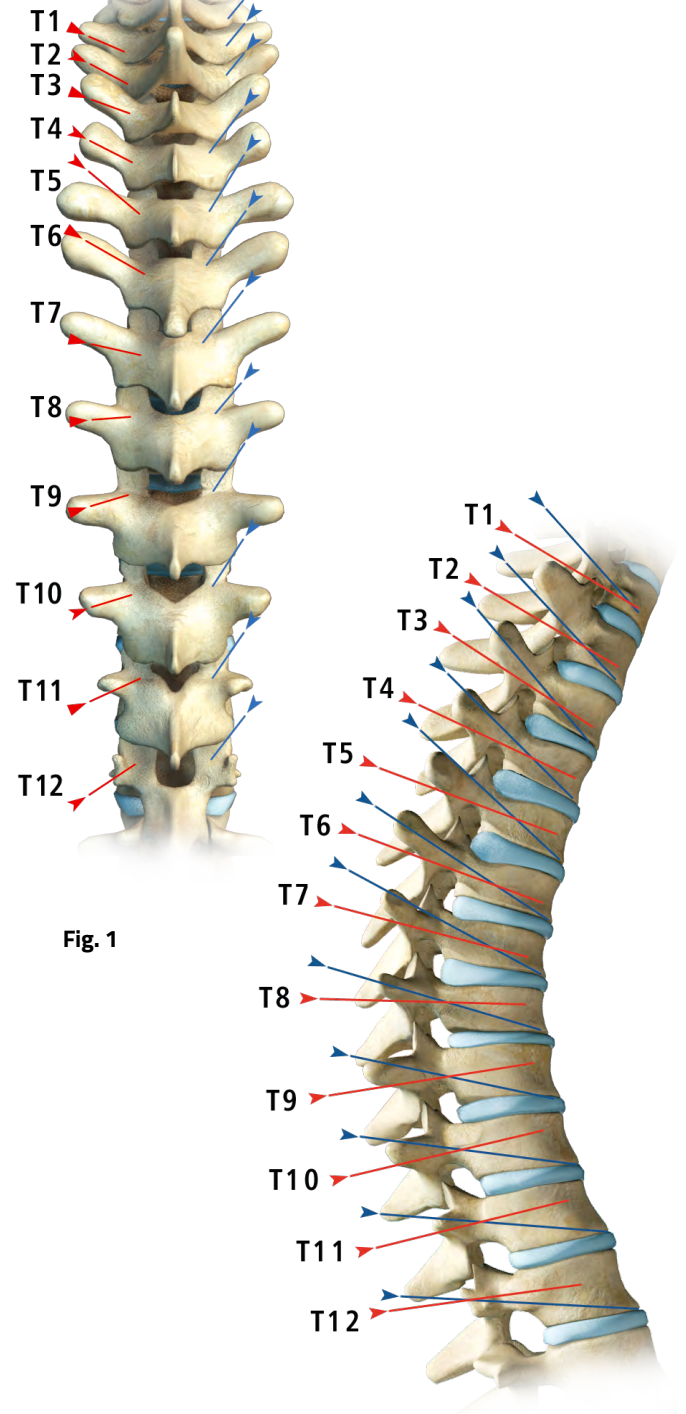

Fig. 1

2. SCREW OPTIONS

NOTE: Please refer to the Firebird Spinal Fixation System Operative Technique regarding steps for pedicle preparation prior to screw insertion, loading bone screws onto the respective drivers and screw adjustment.

Uniplanar Screws (Fig. 2a)

Uniplanar Screws are available in diameters from 4.0 – 6.5mm, in non-modular configuration only. Uniplanar Screws permit screw movement in the cephalad/caudal direction allowing for proper rod placement, yet have restricted motion in the medial/lateral direction, giving them the correction capability of a Mono-Axial Screw. Uniplanar Screws can be distinguished by colored heads matching the bone screws. Insertion should be performed via the Multi-Axial Screw Driver (52-1331). Uniplanar Screws are also available in reduction option (use Multi-Axial Reduction Screw Driver, 61-1331 for insertion).



Fig. 2a



Fig. 2b

Mono-Axial Screws (Fig. 2b)

Mono-Axial Screws may be used for straightforward approaches and direct vertebral body rotation. Insertion should be performed via the Mono-Axial Screw Driver (52-1030).

Multi-Axial Screws (Fig. 2c)

With a 50° cone of angulation, Multi-Axial Screws facilitate secure mating of the screw head and rod for final set screw closure independent of shank trajectory. Insertion should be performed via the Multi-Axial Screw Driver (52-1331).

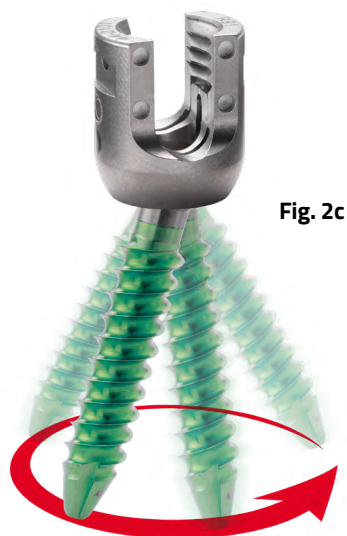

Fig. 2c

Reduction Screws (Fig. 2d)

Reduction Screws have the ability to perform up to 19mm of rod reduction via the tightening of the set screw. The tabs can be broken off after the set screw is below the line of the extended tabs. These screws are available in Multi-, Mono-Axial and Uniplanar varieties. Insertion should be performed via the Multi-Axial (61-1331) or Mono-Axial Reduction Screw Driver (61-1330).



Fig. 2d

3. ROD REDUCTION WITH LINEAR ROD REDUCER

When placing a rod into a modular body or hook, determine the rod contour and length using the trial rod (52-1040/1041/1042).

Contouring of the rod can be achieved by inserting the rod into the hole labeled 5.5 on the Flat Rod Bender (51-1577) and bending to desired contour. There are 2 (two) Flat Rod Benders in the instrument tray to assist in bending.

WARNING: Excessive or repeated bending of rods may reduce strength and result in construct failure.

Additional information on rod insertion can be found in the Firebird Spinal Fixation System Operative Technique.

Capture the rod in the slot at distal end of the Linear Rod Reducer (51-1455). Attach the instrument to pedicle screw by applying axial force until the spring-loaded tips of Linear Rod Reducer snap on and engage the gripping features on the pedicle screw. **(Fig. 3a)**

Push the reduction rack to meet the level of the rod to be reduced. **(Fig. 3b)**

Actuate handles to advance the reduction rack incrementally and persuade the rod into the tulip of pedicle screw. When the rod is fully reduced, the handles will not be able to advance the reduction rack any further. The Linear Rod Reducer will provide up to 30mm of reduction travel. **(Fig. 3c)**

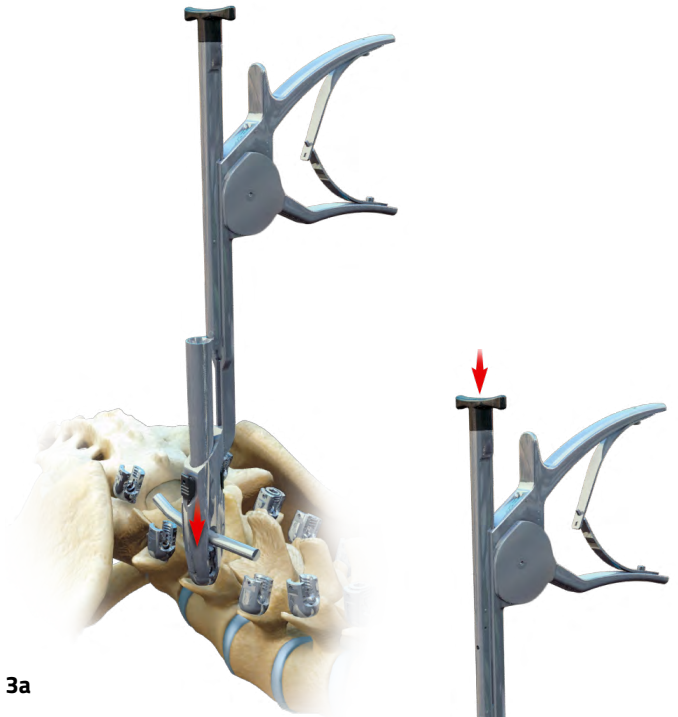

Fig. 3a



Fig. 3b

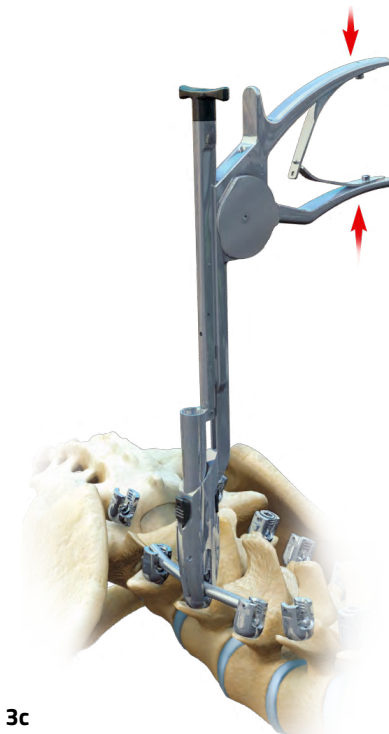

Fig. 3c

Insert a Set Screw using the Set Screw Holder / Driver, Modular, Long (51-1759) through the cannulation in the Linear Rod Reducer.

(Fig. 3d)

Retract the reduction rack by turning its knob ¼ turn counter-clockwise and pulling away from the pedicle screw.

(Fig. 3e)

After the reduction rack has been fully retracted, remove the Linear Rod Reducer from the pedicle screw by depressing the spring loaded tips and easing the instrument off of the screw body.

(Fig. 3f)

CAUTION: Too much reduction force can cause loosening of the screw-pedicle interface.



Fig. 3d

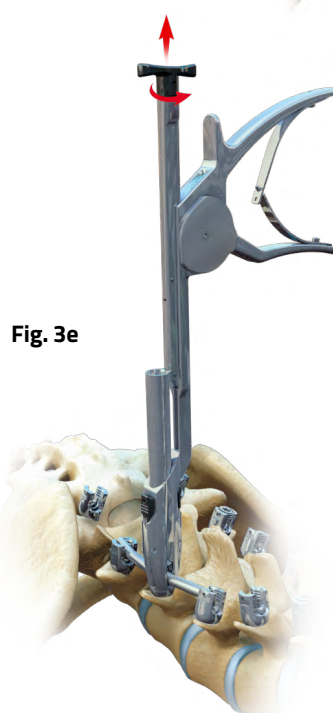

Fig. 3e

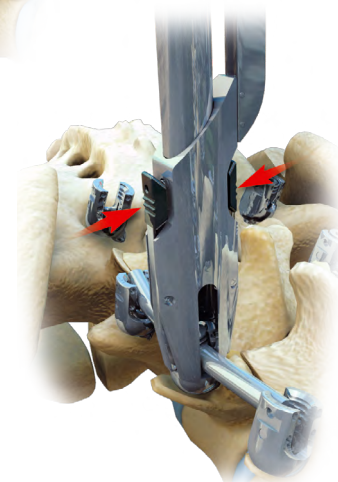

Fig. 3f

4. ROD REDUCTION WITH TUBULAR REDUCER

To expand the distal tip of the Tubular Rod Reducer (51-1989) into its fully unlocked position, turn the drive knob on the proximal end counter-clockwise until flush with the reduction tube. To set the distal tip into the stab-and-grab function, thread the reduction tube proximally only until it meets noticeable resistance. It will naturally slide into this position approximately 3mm from drive knob.

Capture the rod in the slot at the distal tip. Match the pins on the inside of the distal end of the inner tube with the two pin holes on the outside of the screw body. In the fully open position, the inside of the slotted tip will bottom out on the top flats of the screw body. With the stab-and-grab function, the tip will click into place, capturing the screw body. **(Fig 4a & 4b)**

CAUTION: When using the reducer in the fully open position, the instrument can become jammed if it is angled on the screw body. If it becomes jammed during reduction, shift the reducer until it clicks into place.

Rod reduction is achieved by gently holding the outer reduction sleeve and turning the drive knob clockwise. The instrument will provide up to 28mm of reduction travel. **(Fig 4c & 4d)**

Fig. 4a

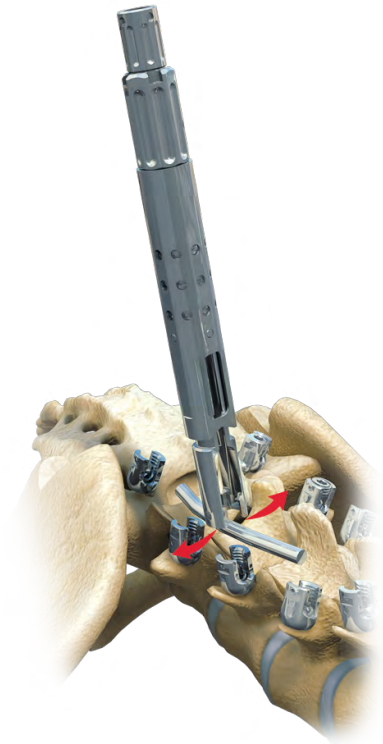

Fig. 4b

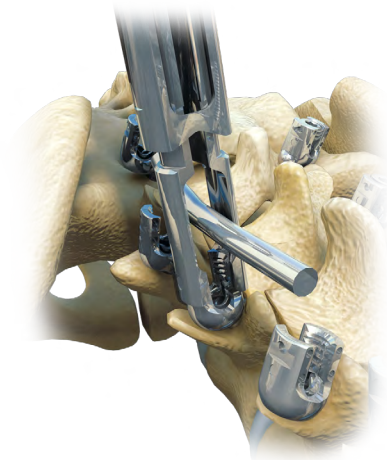
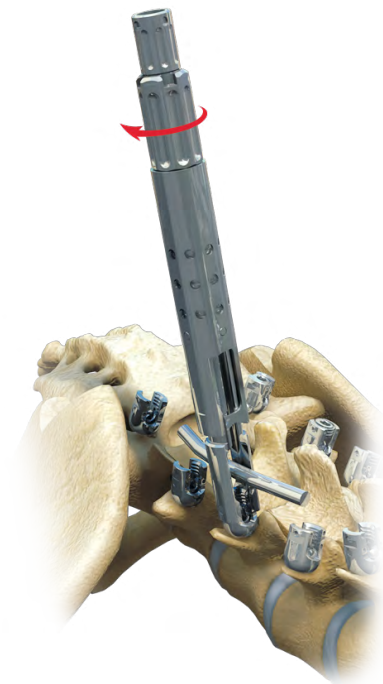

Fig. 4c



If resistance is encountered, the optional driver, Tubular Rod Reducer (51-1990) may be attached to the desired Ratcheting Handle. Slide the Driver over the retention sleeve at the very proximal end, being careful to match the ends of the Driver with the notches in the drive knob. Turn Driver clockwise to complete the reduction maneuver. Complete reduction has been achieved when the drive knob cannot be turned any further. **(Fig 4e)**

Remove the Driver and insert a set screw with provisional tightening using Set Screw Holder/Driver, Modular, Short (51-1758).

To remove the Tubular Reducer **(Fig 4f)** after complete reduction, simply turn the drive knob counter-clockwise past the stab-and-grab position and the Tubular Reducer will lift off the screw body.

NOTE: Both Cobalt Chrome and Titanium Rods are available, based on surgeon preference or stiffness of rod desired. Cobalt Chrome Rods can be recognized by the two black lines laser etched into each rod.

Fig. 4d

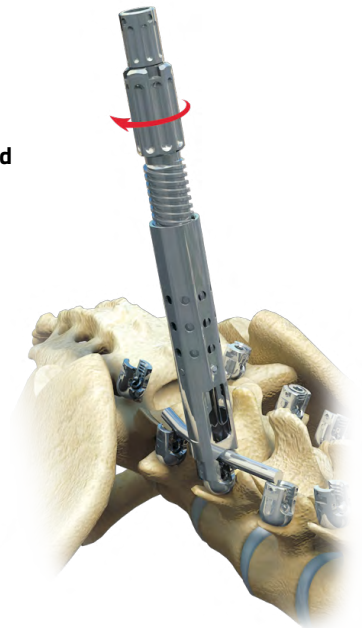

Fig. 4e

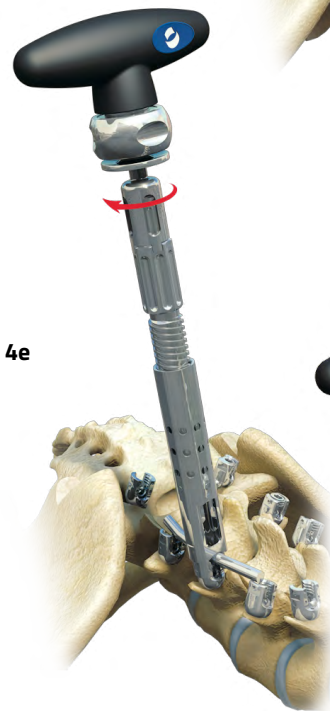

Fig. 4f



5. DIRECT VERTEBRAL ROTATION (DVR)

The Ratcheting Connectors are available in two sizes: **(Fig. 5a)**

Small (51-1988) – Range of 66mm – 91mm

Large (51-1987) – Range of 91mm – 132mm

Using the Ratcheting Connectors to bilaterally attach the Tubular Reducers, Direct Vertebral Rotation can be performed to the desired level. Attach the Ratcheting Connector to the proximal ends of the Tubular Reducers by sliding a spherical interface over each reducer until it bottoms out on the start of the drive knob. **(Fig. 5b)**

(Fig. 5b)

To adjust the medial/lateral size of the Ratcheting Connector, slide the rack to the desired length and turn the top knob 90° to the locked position. **(Fig. 5c)**

To adjust the trajectory of the Tubular Reducers based on pedicle anatomy, find the desired orientation and turn the lever at each end of the Ratcheting Connector a ¼ turn until the spherical interfaces are tightened around the retention sleeve. **(Fig. 5d)**

Attach the Rotation Handle (51-1486) to handle connector on top of the Ratcheting Connector. **(Fig. 5e)**

Repeat steps in Fig. 5a through Fig. 5e for each level to be rotated. **(Fig. 5f)**

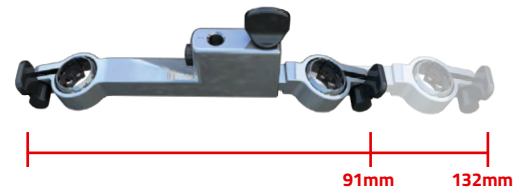

Fig. 5a

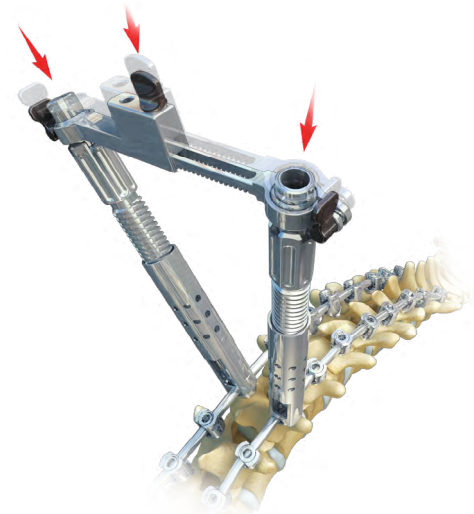
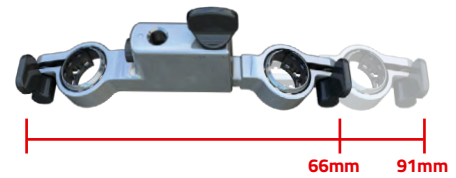

Fig. 5b

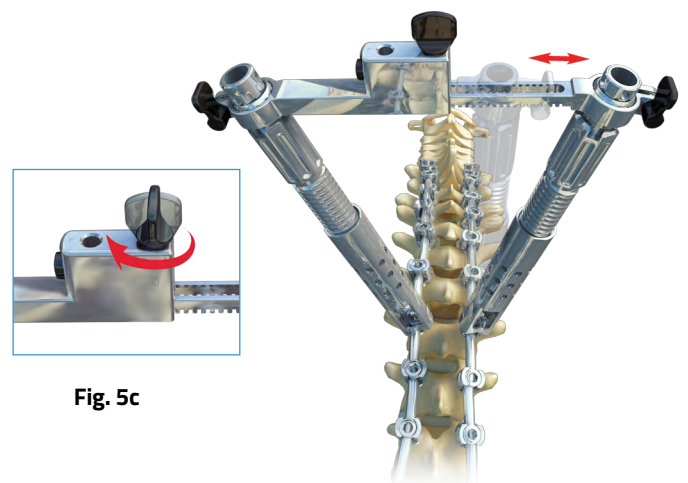

Fig. 5c



Fig. 5d

If final tightening of Set Screws is desired after rotation, it may be achieved by using Set Screw Driver (52-1061) along with the Torque Limiting Handle (52-1512) (**Fig. 5g**).

NOTE: Counter Torque Wrench is not required as linked Tubular Reducers provide counter torque during final tightening.

NOTE: The Firebird Spinal Fixation System includes both Mono-Axial and Uniplanar Screws to assist with DVR maneuvers.

NOTE: To remove Ratcheting Connectors from Tubular Reducers, turn the lever up until spherical interfaces are loosened around Tubular Reducers.

Fig. 5e

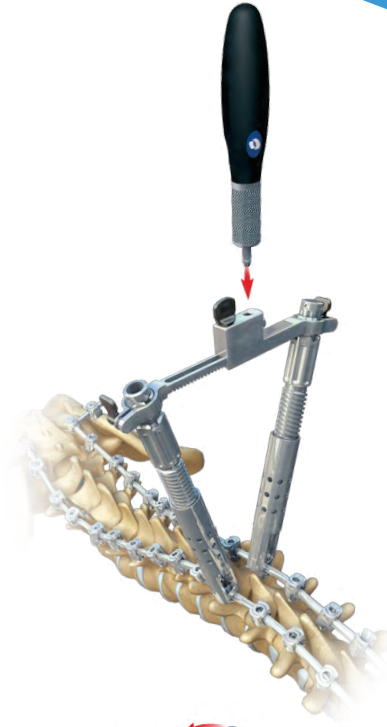

Fig. 5f

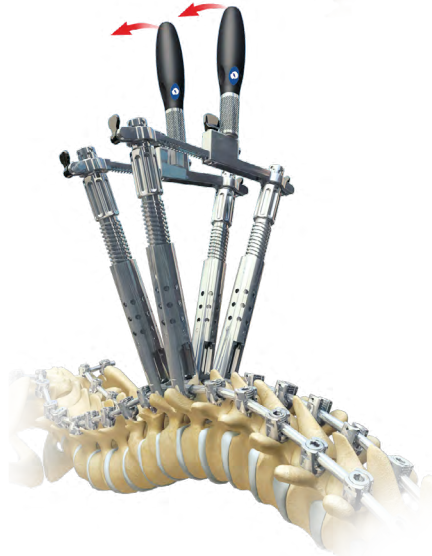

Fig. 5g



6. ROD ROTATION

Utilize Hex Wrench (51-1580) to rotate the rod to its desired orientation by engaging wrench on the hex feature at end of the rod. An angled end of the hex wrench is provided to accommodate patient anatomy.

Rod Grippers (51-1480) can be used to facilitate rotation of the rod to desired orientation along its length. Multiple Rod Grippers can also be used to incrementally rotate the rod to desired orientation. **(Fig. 6)**

Grip strength of Rod Grippers can be adjusted by turning knob in the center of handle.

CAUTION: Do not set Rod Gripper to position that does not allow Rod Gripper to close on rod. Excessive clamping force may lead to failure of instrument.

7. IN-SITU ROD CONTOURING

Coronal Rod Benders (51-1475, 51-1476) are provided to achieve additional coronal balance after the implantation of the rod. Place Coronal Rod Benders along rod and contact the knurled surface of each instrument to provide leverage during rod contouring. **(Fig. 7)**

NOTE: Sagittal contouring can be performed using the In-Situ Rod Benders Right and Left (52-1070, 52-1071) in the standard Firebird instrument set.

WARNING: Excessive or repeated bending of rods may reduce strength and result in construct failure.

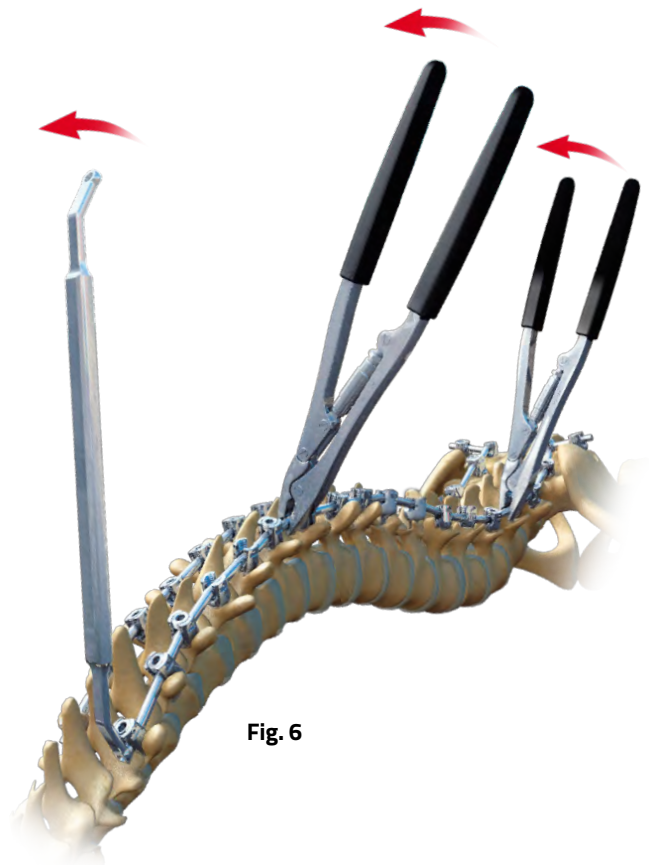

Fig. 6

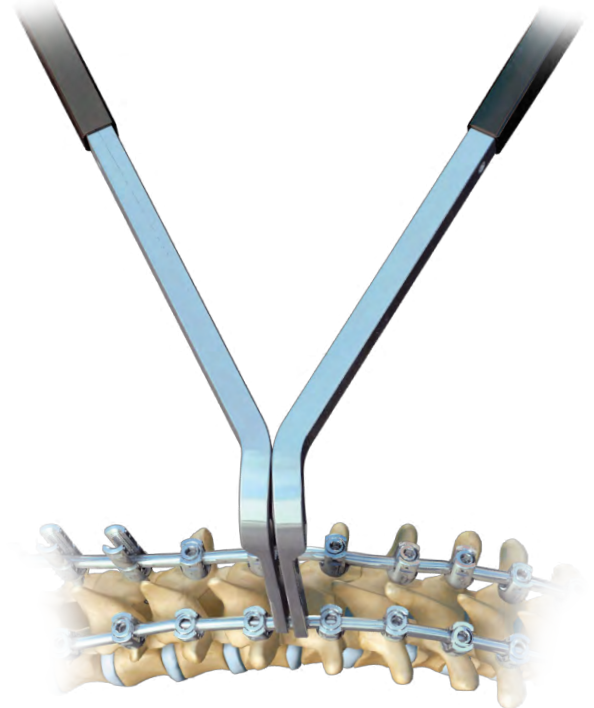

Fig. 7

8. FINAL SET SCREW TIGHTENING

Counter Torque Wrench (52-1265)

Set Screw Driver (52-1061)

Torque Limiting Handle (52-1512)

Position the Counter Torque Wrench over the pedicle screw and rod. Place the Set Screw Driver through the cannulation of the Counter Torque Wrench and into the hex of the Set Screw. Turn the Torque Handle clockwise to tighten. The handle will reach its maximum torque and release at 100 in-lbs. **(Fig. 8)**

NOTE: Markings on the top round surface of the Counter Torque Wrench should be used to seat the instrument properly. The three lines must always be aligned with the length of the implanted rod. The top button can be pushed in order to rotate the tube into the correct orientation.

(OPTIONAL) CROSS CONNECTIONS

Cross-Connector Calipers (52-1101)

Cross-Connector Benders, Right (52-1102) and **Left** (52-1103)

Cross-Connector Driver (52-1104)

The appropriate size Cross-Connector is determined with the Cross-Connector Calipers. The appropriate multi-axial or fixed Cross-Connector is chosen and placed between the two rods in the construct. If contouring of the multi-axial cross-connector is needed, use the Cross-Connector Benders, right and left.

Once the correct position of the Cross-Connector is established on the rods, use the Cross-Connector Driver to advance each of the set screws. Fixate the Cross-Connectors onto the rods applying 13 in-lbs of torque. It is recommended to alternate tightening from side to side in order to get uniform closure onto both rods.

REMOVAL PROCEDURE:

Removal of implants should be performed as outlined in the Firebird Spinal Fixation Operative Technique.



Fig. 8

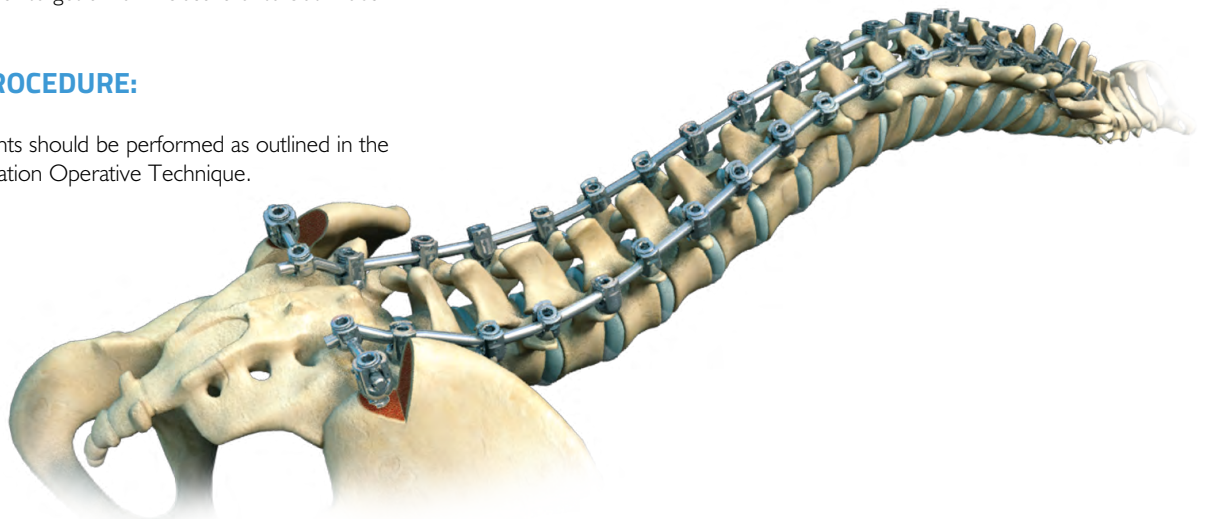

ILIAC FIXATION OPERATIVE TECHNIQUE

The Firebird Iliac Fixation module provides a variety of connection options that cater to spinal deformities including neuromuscular or idiopathic scoliosis with pelvic obliquity, or when additional load sharing is needed at the lumbosacral junction.

1. APPROACH TO THE ILIAC CREST

The iliac crest and posterior superior iliac spine are exposed with the surgeon's preferred method. Care should be taken to expose enough of the iliac crest to allow a proper trajectory of the bone screw and ensure the iliac cortex is not compromised during intraosseous placement of the screw. **(Fig. 1)**

2. PREPARATION OF THE ILIAC CREST

It is recommended to notch the iliac crest sufficiently enough around the screw head to sink it to a level obviating implant prominence. **(Fig. 2)**

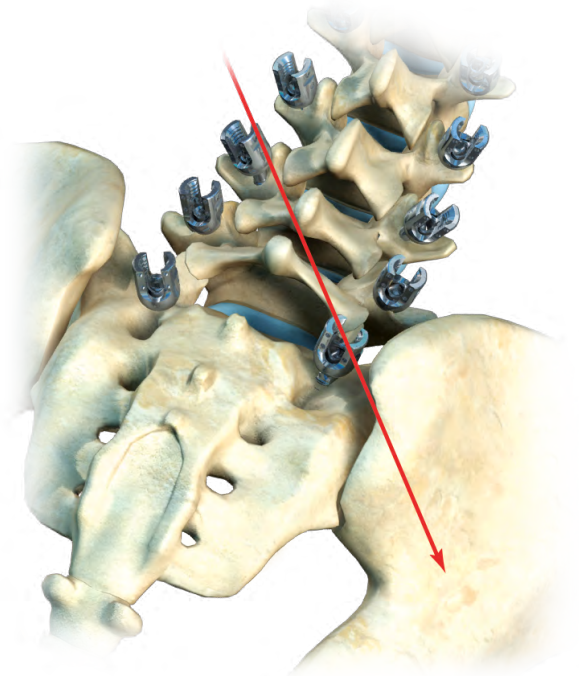

Fig. 1

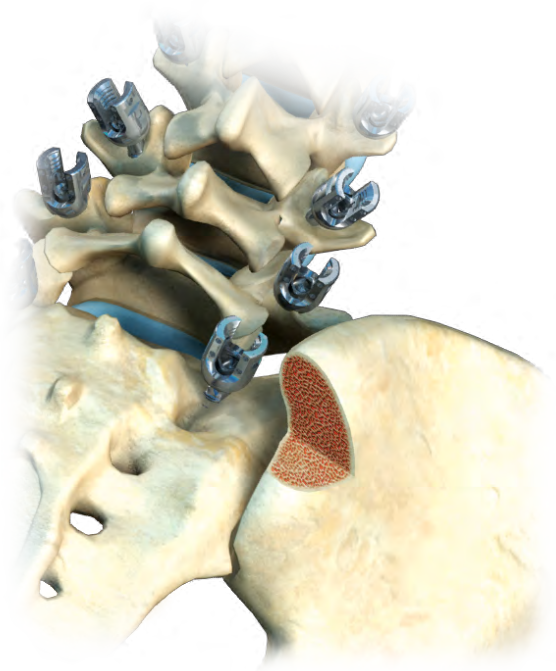

Fig. 2

3. PROBING THE ILIUM

Place the Iliac Bone Probe Duckbill (51-1303) in such a way that the path is approximately 1.0mm to 1.5mm above the greater sciatic notch. The probe can be used to start the screw path but does not need to extend the entire length of the chosen screw. When choosing a screw size, it is generally considered best to use the largest diameter possible. (Fig. 3a)

Fig. 3a

(OPTIONAL) TAPPING THE ILIAC

Tap to the appropriate depth based on the length of the bone screw to be implanted for optimized screw purchase, using the millimeter markings on either the Iliac Bone Tap, Modular (51-1027, 1028, 1029) or the Iliac Bone Probe (51-1302 or 51-1303) as a guide. (Fig. 3b)

NOTE: Self-tapping screws do not require the use of a tap to facilitate screw insertion.

4. INSERTING MODULAR BONE SCREWS IN THE ILIAC CREST

Attach the appropriate bone screw onto the Modular Screw Driver (52-1332) by placing the head of the bone screw into the distal tip. Turn the knob clockwise until the sleeve completely surrounds the collar. Ensure the bone screw is rigidly fixed on the distal tip and is in alignment with the driver shaft before using. (Fig. 4a)

Insert the bone screw into the prepared ilium until it is positioned to the correct level. The bone screw should extend far enough above the iliac crest to allow for insertion of the screw body or connector. (Fig. 4b)

To disengage the bone screw from the screw driver tip, turn the knob counter-clockwise until the instrument disengages from the bone screw.

NOTE: An optional Decorticating Planer (52-1334) is available for decorticating over the spherical head of the bone screw.

NOTE: If iliac connectors and bone screws will be used in the iliac crest, bone screw fixation must extend to S1/S2 to ensure a stable construct.

Fig. 3b



Fig. 4a

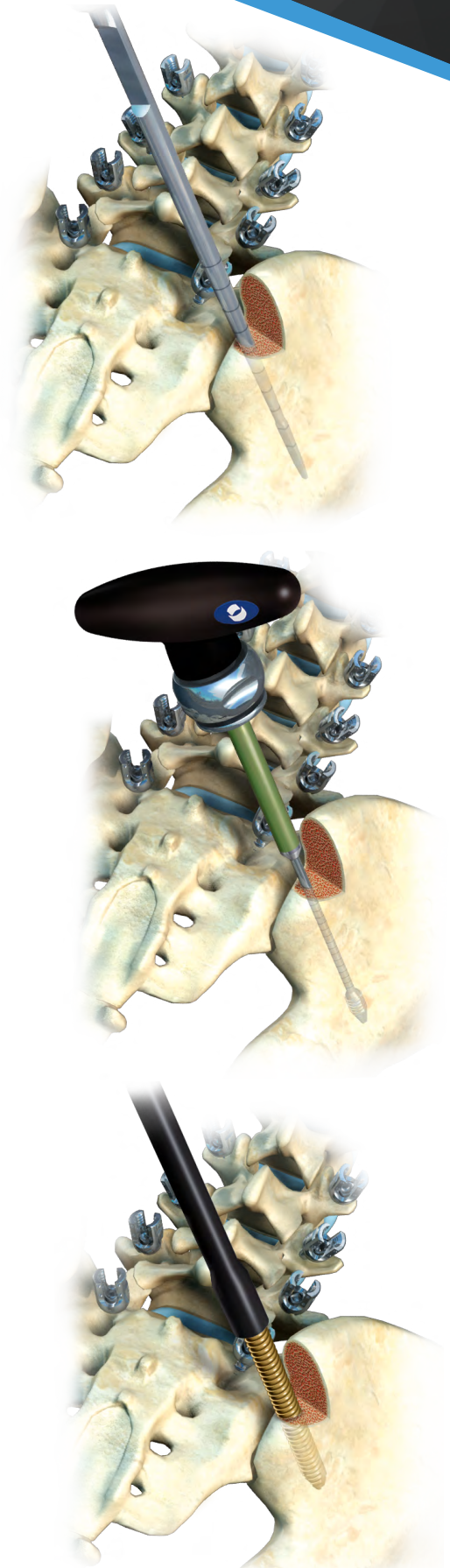

Fig. 4b

5. MULTI-AXIAL BODY INSERTION

To attach the appropriate modular body to the Multi-Axial Body Inserter (54-0007), align pin holes on the modular body with the inserter and then clamp.

(Fig. 5a) Slide the body onto the bone screw by applying an axial force to connect the base of the body to the spherical head of the bone screw **(Fig. 5b and 5c)**. The pressure cap will move freely in the body to allow for proper insertion. Confirm a secure connection between the body and bone screw by pulling up on the Body Inserter prior to disconnecting. **(Fig. 5d)** When the body remains attached to the bone screw, the assembly is secure.

6. ILIAC CONNECTOR OPTIONS

The Firebird Deformity Correction System provides two options to connect a construct to the ilium:

Mono-Axial Lateral Offset (Fig. 6a)

- Available in lengths from 15 – 35mm in 5mm increments.
- An 80mm connector is provided and may be cut to the desired length by the surgeon prior to implantation.
- In-situ cutting is available using In situ Rod Cutter (59-1041) (by request only)

Application Of Mono-Axial Lateral Offset (Fig. 6b)

Preload the Mono-Axial Lateral Offset onto the Head Inserter Insert longitudinal rod into iliac screw and preliminarily fixate with set screw.

NOTE: When used for fixation to the ilium, the offset connectors of the Firebird Spinal Fixation System must be used in conjunction with pedicle screws placed at the S1 or S2 spinal level. Use of the Firebird offset connectors for fixation to the ilium is contraindicated when the sacrum is absent or insufficient for implantation of pedicle screws at the S1 or S2 spinal level.

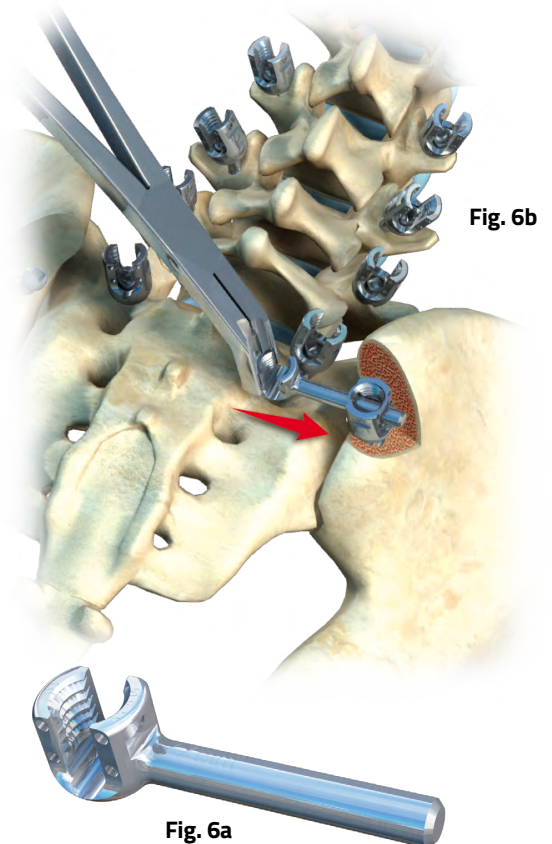
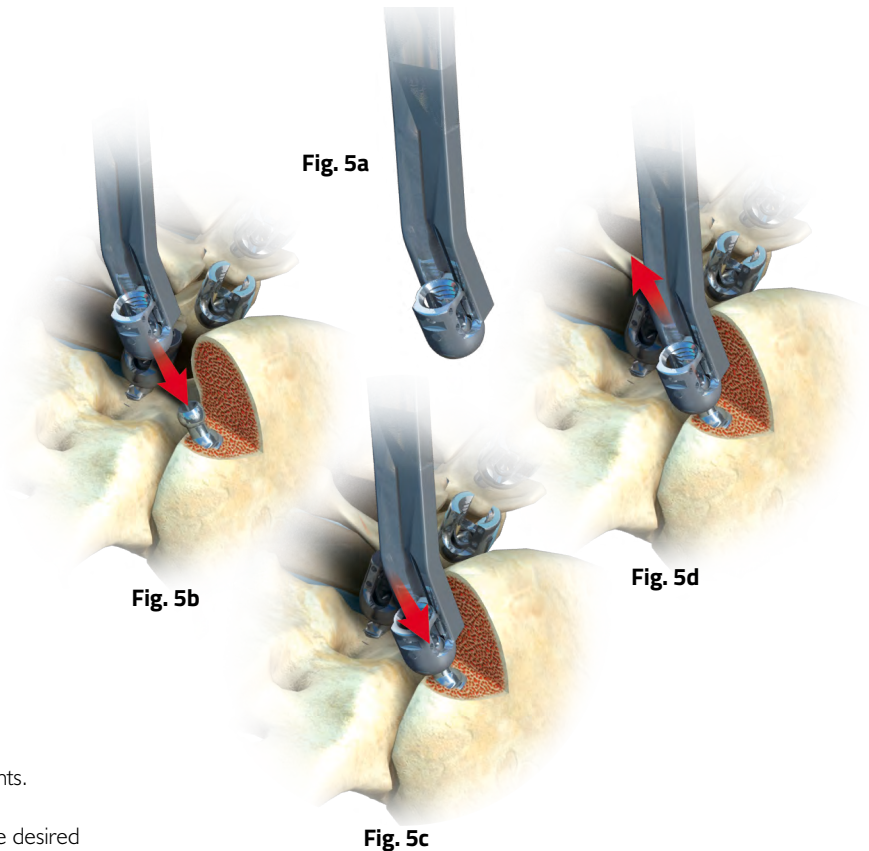

Low Profile Offset (Fig. 6c)
(For use with modular bone screws only)

- Available in lengths from 8 – 35mm in 3mm increments

NOTE: Notching of the pelvis is reduced if using the Low Profile Offset Iliac Connectors.

Measuring with Low Profile Offset Template

The Low Profile Offset Template (51-1601) is used in order to correctly size the Low Profile Offset prior to assembling it with the bone screw. The screw arm of the template, which can be identified by its cupped tip, is first fitted around the bone screw head protruding from the ilium. The template tips should then be widened until the simulated rod attached to the rod arm is aligned with the implanted lumbrosacral bone screws. The size for the corresponding Low Profile Offset can then be read off of the scale of the template featured on the very proximal end.

NOTE 1: The simulated rod can be slid back and forth along its axis in order to accommodate both sides of the ilium.

Application of Low Profile Offset (Fig. 6d)

Preload the correctly sized Low Profile Offset onto the Head Insert. It should be grasped near the open end configured for use with a rod. If a rod is in place, this end can be angled under the rod and then slid into position. The end with the included Set Screw can then be joined with the iliac bone screw head.

CAUTION: Do not assemble Low Profile Offset onto bone screw until appropriate length is confirmed. Disassembly is not possible and will therefore require bone screw removal.

NOTE 2: The Integrated Set Screw can be removed from implant if removal / revision is required. If removed, ensure Low Profile Offset Set Screw (44-2002) is used to fixate Low Profile Offset to the bone screw. The Offset Set Screw and corresponding location on Low Profile Offset both feature laser marked dots to indicate compatibility. Set Screw (44-2001) should continue to be used to fixate rod to Low Profile Offset.

NOTE 3: Although the screws provided in the iliac fixation implant tray are provided in a modular configuration, the surgeon has the option of assembling the heads prior to screw insertion if desired.

NOTE 4: The Mono-Axial Lateral Offset and Low Profile Offset may also be used at points along the construct to connect to a screw that may be lateral and out of line with the pedicle screw at adjacent levels.

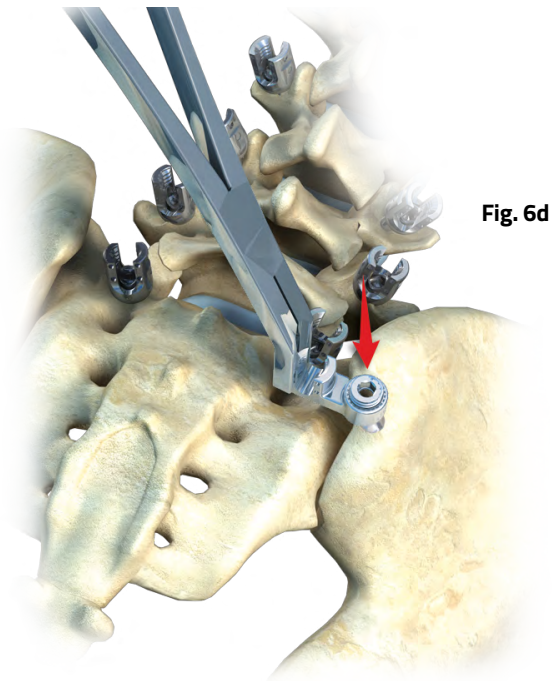

Fig. 6d

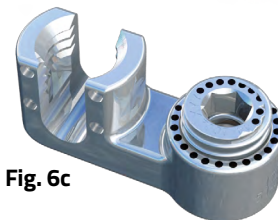

Fig. 6c

7. SET SCREW TIGHTENING

Counter Torque Wrench (52-1265)

Set Screw Driver (52-1061)

Torque Limiting Handle (52-1512)

Position the Counter Torque Wrench over the pedicle screw and rod. Place the Set Screw Driver through the cannulation of the Counter Torque Wrench and into the hex of the Set Screw. Turn the Torque Handle clockwise to tighten. The handle will reach its maximum torque and release at 100 in-lbs. **(Fig. 7)**

NOTE: Markings on the top round surface of the Counter Torque Wrench should be used to seat the instrument properly. The three lines must always be aligned with the length of the implanted rod. The top button can be pushed in order to rotate the tube into the correct orientation.

REMOVAL PROCEDURE:

Removal of implants should be performed as outlined in the Firebird Spinal Fixation Operative Technique.

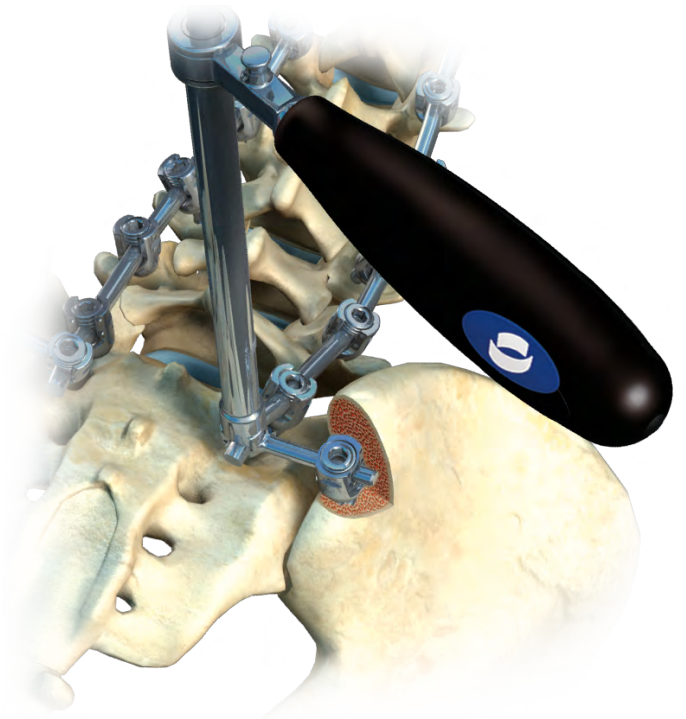
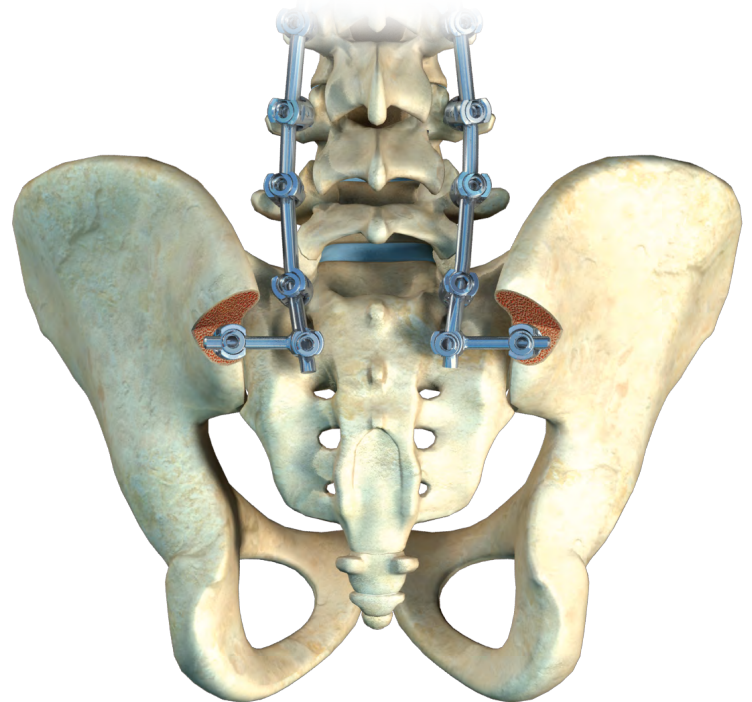

Fig. 7



Hook Fixation Operative Technique

An alternative to the use of pedicle screws for spinal fixation, posterior element hook fixation is still a valuable adjunct in many situations where screws are not possible or desirable, or need to be supplemented.

Firebird Hooks are top loading and come in various orientations, throat sizes, and blade widths. Hook selection depends on where the desired force is to be applied and in what direction based on the patient's anatomy, deformity, and preferred method of correction.

1. GENERAL HOOK PREPARATION

Site preparation prior to hook placement necessitates meticulous soft tissue debridement in order to define the bony anatomy facilitating proper seating of the hook. Bone preparation depends on the site of application and type of hook used. Proper use of provided instrumentation allows safe placement with optimal stability and minimal risk to adjacent neurovascular structures.

2. LAMINAR HOOK INSERTION

Laminar Hooks may be placed in either an up going infra-laminar location to deliver a cephalad directed force or in a down going supra-laminar location to deliver a caudal directed force.

Infra-laminar up going hook preparation is facilitated by separating the ligamentum flavum from the underside of the lamina using the Laminar Elevator (51-7622). Ligamentum removal is not usually necessary since it attaches cephalad to the inferior edge of the lamina. As with all hooks, it is imperative to avoid intraosseous hook placement to minimize the risk of hook pullout. An impaction cap is provided to apply force as necessary to ensure full seating of the hook against the inferior edge of the lamina. **(Fig.1)**

Supra-laminar down going hooks pose the greatest risk to underlying neurologic structures due to the ventral inclination of the superior lamina and the more dorsal attachment of the ligamentum flavum which necessitates its removal for proper hook seating. The midline ligamentous raphe is identified with a Leksell rongeur and then enough ligamentum flavum and minimal lamina is removed to allow the hook to be rotated or "rolled" underneath the lamina while grasping it with a hook holder. The throat depth of the hook should match the lamina thickness to prevent unnecessary penetration of the hook into the spinal canal during hook and rod insertion. This hook is preferably used to apply a posteriorly directed force, away from the neural elements.



Fig. 1

3. PEDICLE HOOK INSERTION

Completely excise the facet capsule with the bovie and/or curettes to define the joint. Use the Pedicle Elevator (51-7621) to open the joint and locate the pedicle as an endpoint while avoiding intraosseous penetration of the descending facet, often caused by underestimating the kyphotic angulation of the spine in the upper thoracic region. **(Fig. 2)**

Squaring off the caudal edge of the descending facet with an osteotome or drill may facilitate placement. Hook must be within facet joint and engaging the pedicle as evidenced by medial/lateral stability.

4. TRANSVERSE PROCESS HOOK INSERTION

Transverse Process Hooks are usually applied in a down going direction over the superior surface, using a hook holder. Use a bovie and/or Transverse Process Elevator (51-7620) to detach the ligament from the superior edge. Ensure elevator and subsequent hook blade goes around entire process and is not intraosseous. **(Fig. 3)**

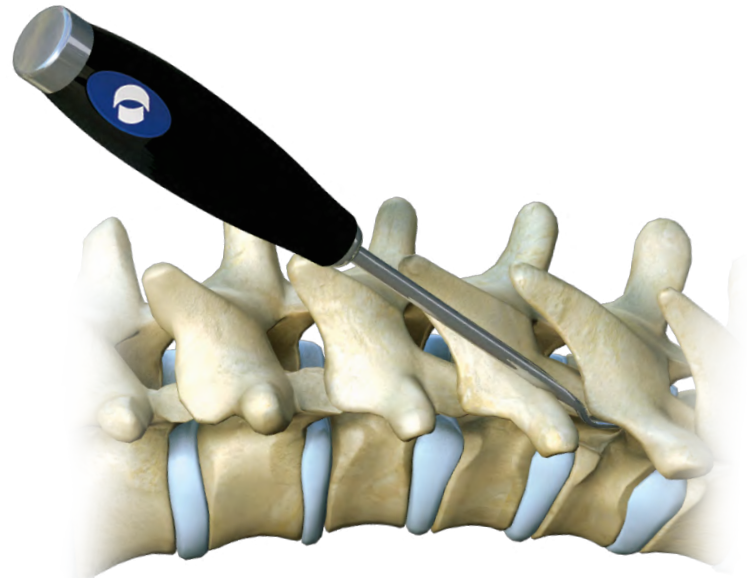

Fig. 2



Fig. 3

5. OFFSET AND ANGLED HOOK INSERTION

Use of Offset and Angled Hooks are dependent on the anatomical need, procedure type, and surgeon preference. **(Fig. 4a and 4b)**

6. HOOK HOLDERS

The Regular Hook Holders (Straight/Angled) (51-7100/51-7601) attach securely to each side of the hook tulip, while the Lateral Hook Holders (Straight/Angled) (51-7105/51-7606) attach to the hook on a single side.

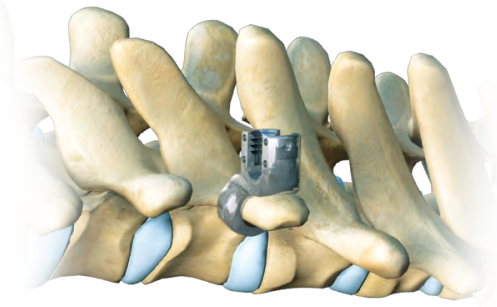

Fig. 4a

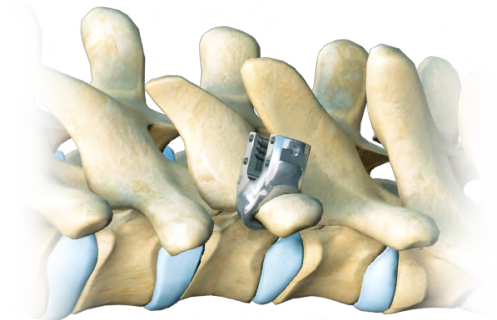

Fig. 4b



Fig. 5a

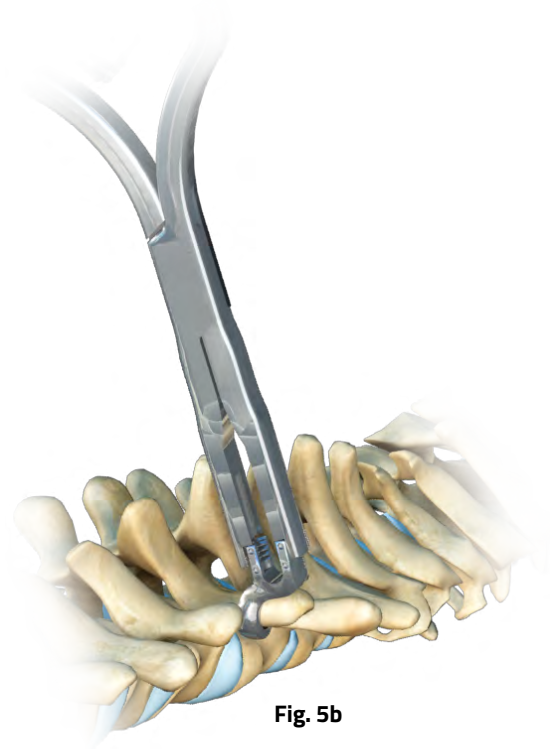

Fig. 5b

7. HOOK PUSHER

If necessary, the Hook Pusher (51-7111) may be used to apply a controlled force in the direction of hook application. This is most commonly used with pedicle hooks and occasionally laminar or transverse process hooks.

With the scalloped knob loosened fully counter-clockwise, place hook in distal end of pusher. Secure hook to instrument by rotating clockwise until finger tight and gripper plate makes full contact with hook. *Care should be taken to not overtighten the hook pusher.*

(Fig. 6a)

An impaction cap is provided to allow controlled mallet strike as necessary for final hook seating. **(Fig. 6b)**

Loosen knob by turning counter-clockwise to disengage while holding hook in seated position, then lifting to remove. **(Fig. 6c)**

Fig. 6a

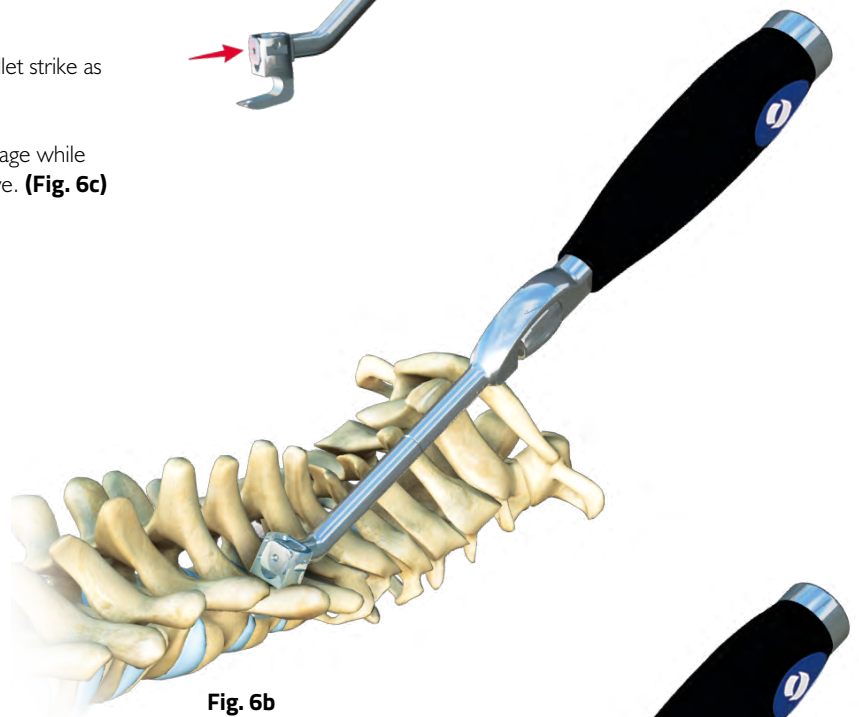
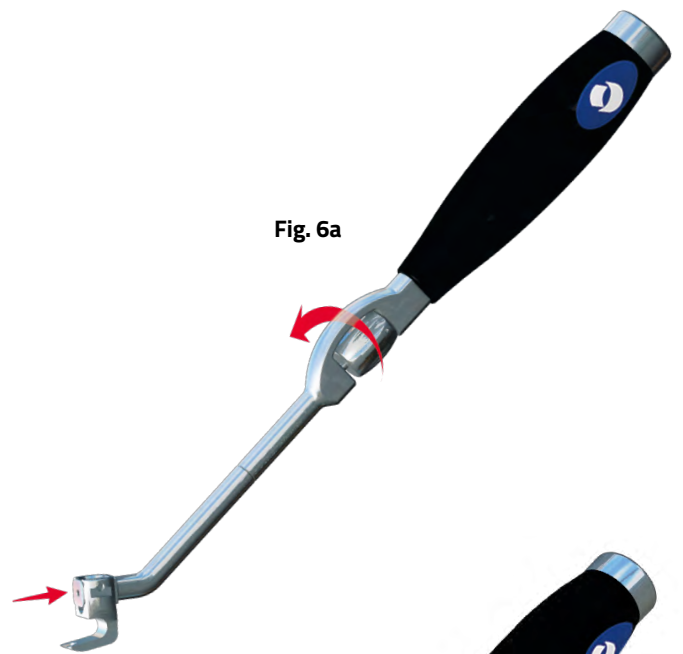

Fig. 6b

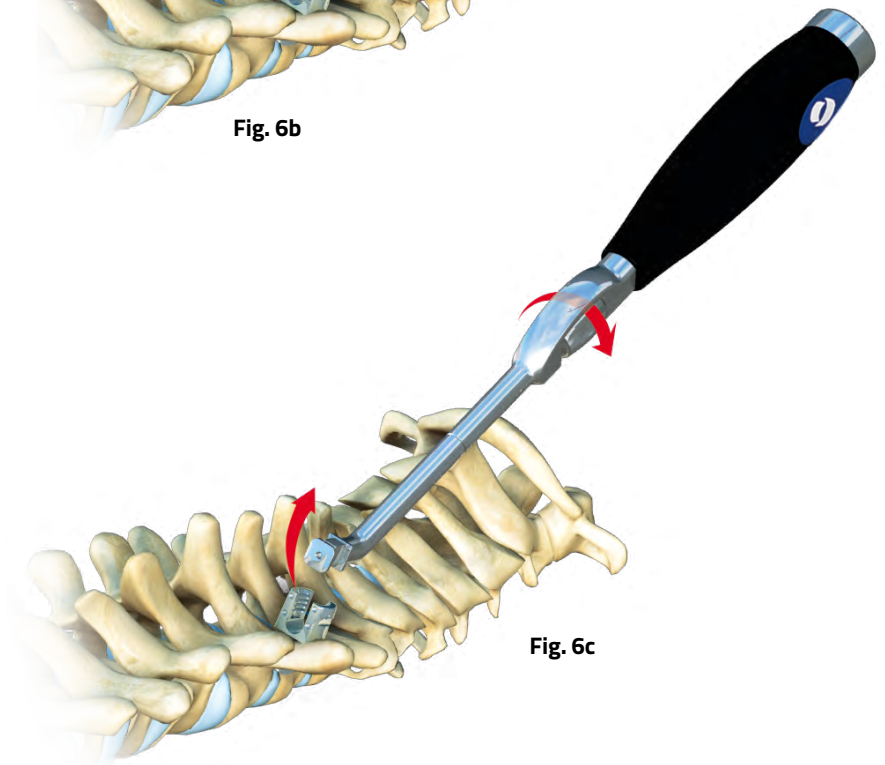

Fig. 6c

8. FINAL SET SCREW TIGHTENING

Counter Torque Wrench (52-1265)

Set Screw Driver (52-1061)

Torque Limiting Handle (52-1512)

Position the Counter Torque Wrench over the pedicle screw and rod. Place the Set Screw Driver through the cannulation of the Counter Torque Wrench and into the hex of the Set Screw. Turn the Torque Handle clockwise to tighten. The handle will reach its maximum torque and release at 100in-lbs.

(Fig. 7)

NOTE: Markings on the top round surface of the Counter Torque Wrench should be used to seat the instrument properly. The three lines must always be aligned with the length of the implanted rod. The top button can be pushed in order to rotate the tube into the correct orientation.

HOOK REMOVAL

Remove set screw and rod from hook as described in Firebird Spinal Fixation System Operative Technique.

Option A:

- a) Attach desired hook holder (51-7100, 51-7101, 51-7105, 51-7106) to hook by matching pins on hook holder to holes on sides of modular head and compress handles to secure.
- b) Carefully remove hook from anatomy

Option B:

- a) Attach hook pusher (51-7111) onto modular head of hook and turn knob on handle of hook pusher clockwise to engage.
- b) Carefully remove hook from anatomy.

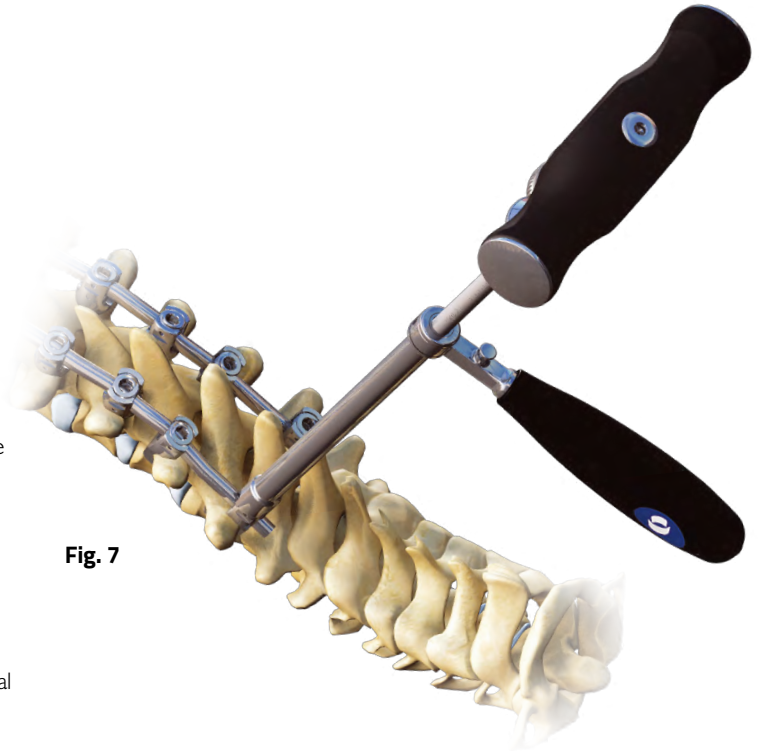

























Fig. 7

Implant/Instrument Catalog





ILIAC FIXATION 51-9560

Implants

	Part #	Description	Qty Set
	44-2001	Set Screw	30
	44-2101	Body, Top Loading	30
	44-2102	Body, Closed	10
	44-5760	7.5mm x 60mm Bone Screw, Self Tapping	2
	44-5770	7.5mm x 70mm Bone Screw, Self Tapping	2
	44-5780	7.5mm x 80mm Bone Screw, Self Tapping	2
	44-5790	7.5mm x 90mm Bone Screw, Self Tapping	2
	44-5710	7.5mm x 100mm Bone Screw, Self Tapping	2
	44-5860	8.5mm x 60mm Bone Screw, Self Tapping	2
	44-5870	8.5mm x 70mm Bone Screw, Self Tapping	2
	44-5880	8.5mm x 80mm Bone Screw, Self Tapping	2
	44-5890	8.5mm x 90mm Bone Screw, Self Tapping	2
	44-5810	8.5mm x 100mm Bone Screw, Self Tapping	2
	44-5960	9.5mm x 60mm Bone Screw, Self Tapping	2
	44-5970	9.5mm x 70mm Bone Screw, Self Tapping	2
	44-5980	9.5mm x 80mm Bone Screw, Self Tapping	2
	44-5990	9.5mm x 90mm Bone Screw, Self Tapping	2
	44-5910	9.5mm x 100mm Bone Screw, Self Tapping	2
	44-5060	10.5mm x 60mm Bone Screw, Self Tapping	2
	44-5070	10.5mm x 70mm Bone Screw, Self Tapping	2
	44-5080	10.5mm x 80mm Bone Screw, Self Tapping	2
	44-5090	10.5mm x 90mm Bone Screw, Self Tapping	2
	44-5010	10.5mm x 100mm Bone Screw, Self Tapping	2







ILIAC FIXATION 51-9560

Implants

	Part #	Description	Qty Set
	5I-6315	Mono-Axial Lateral Offset, 15mm	2
	5I-6320	Mono-Axial Lateral Offset, 20mm	2
	5I-6325	Mono-Axial Lateral Offset, 25mm	2
	5I-6330	Mono-Axial Lateral Offset, 30mm	2
	5I-6335	Mono-Axial Lateral Offset, 35mm	2
	5I-6380	Mono-Axial Lateral Offset, 80mm	2
	5I-6408	Low Profile Offset, 8mm	2
	5I-6411	Low Profile Offset, 11mm	2
	5I-6414	Low Profile Offset, 14mm	2
	5I-6417	Low Profile Offset, 17mm	2
	5I-6420	Low Profile Offset, 20mm	2
	5I-6423	Low Profile Offset, 23mm	2
	5I-6426	Low Profile Offset, 26mm	2
	5I-6429	Low Profile Offset, 29mm	2
	5I-6432	Low Profile Offset, 32mm	2
	5I-6435	Low Profile Offset, 35mm	2
	52-2450	450mm Rod, Ti	4
	5I-2450	450mm Rod, CoCr	4

ILIAC FIXATION 51-9560

Instruments

	Part #	Description	Qty Set
	51-1027	7.5mm Bone Tap, Modular	1
	51-1028	8.5mm Bone Tap, Modular	1
	51-1029	9.5mm Bone Tap, Modular	1
	51-1577	Flat Rod Bender	2
	52-1011	Ratcheting Handle, T-Handle	1
	52-1013	Ratcheting Handle, Straight, Small	1
	51-1303	Iliac Bone Probe, Duckbill	1

ILIAC FIXATION 51-9560

Implant/Instrument Case

Part #	Description	Qty Set
51-0560	Iliac Fixation Case	1



Iliac Fixation Case Level 1

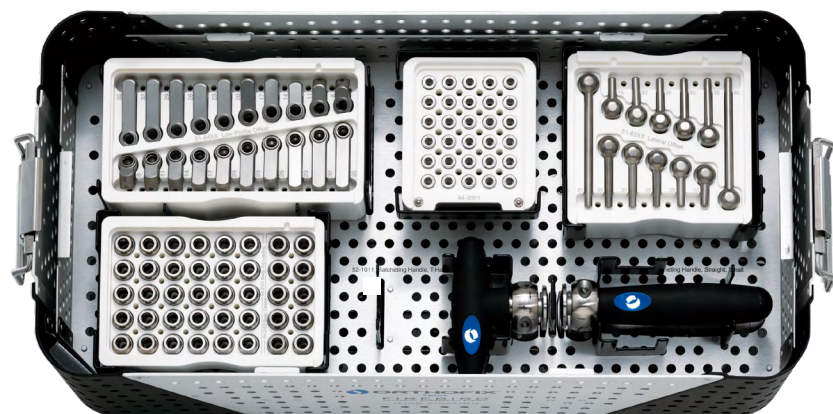



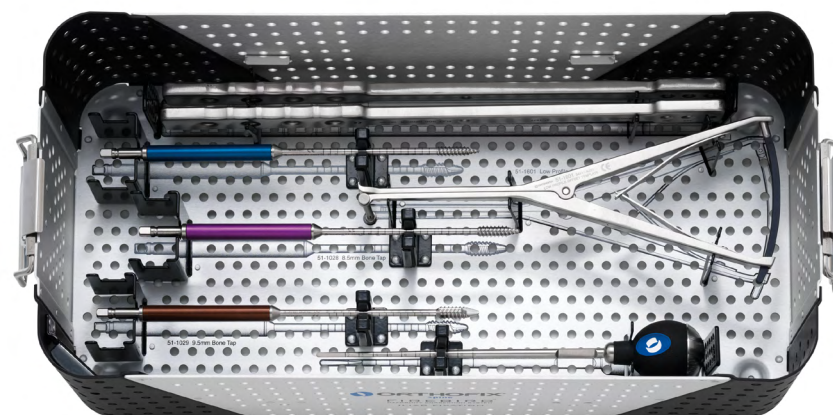





Iliac Fixation Case Level 2











Iliac Fixation Case Level 3

HOOK FIXATION 51-9570

Implants			
	Part #	Description	Qty Set
	44-2001	Set Screw	30
	51-2450	450mm Rod, CoCr	4
	52-2450	450mm Rod, Ti	4
	51-7010	Angled Hook, Left, Small	4
	51-7011	Angled Hook, Left, Medium	4
	51-7020	Angled Hook, Right, Small	4
	51-7021	Angled Hook, Right, Medium	4
	51-7030	Laminar Hook, Narrow, Small	4
	51-7031	Laminar Hook, Narrow, Medium	4
	51-7032	Laminar Hook, Narrow, Large	4
	51-7040	Laminar Hook, Wide, Small	4
	51-7041	Laminar Hook, Wide, Medium	4
	51-7042	Laminar Hook, Wide, Large	4
	51-7050	Offset Hook, Left, Medium	4
	51-7051	Offset Hook, Left, Large	4
	51-7060	Offset Hook, Right Medium	4
	51-7061	Offset Hook, Right, Large	8
	51-7070	Pedicule Hook, Small	8
	51-7071	Pedicule Hook, Medium	4
	51-7072	Pedicule Hook, Large	6
	51-7080	Thoracic Hook, Narrow, Small	6
	51-7081	Thoracic Hook, Narrow, Medium	4
	51-7090	Thoracic Hook, Wide, Small	4
	51-7091	Thoracic Hook, Wide, Medium	4

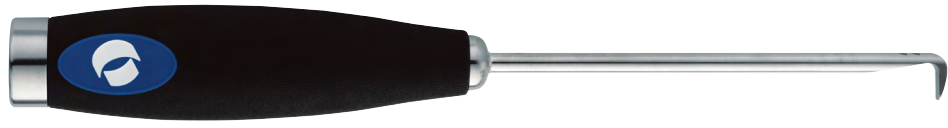
HOOK FIXATION 51-9570

Instruments

Part #	Description	Qty Set	Part #	Description	Qty Set
51-7100	Hook Holder, Regular, Straight	2	51-7105	Hook Holder, Lateral, Straight	2
					
51-7601	Hook Holder, Regular, Angled	2	51-7606	Hook Holder, Lateral, Angled	2
					
Part #	Description	Qty Set			
51-7620	Transverse Process Elevator	1			
					
51-7621	Pedicle Elevator	1			
					
51-7622	Laminar Elevator	1			
					
51-7111	Hook Pusher	1			
					

HOOK FIXATION 51-9570

Implant/Instrument Case

Part #	Description	Qty Set
51-0570	Hook Fixation Case	1



Hook Fixation Case
Level 1

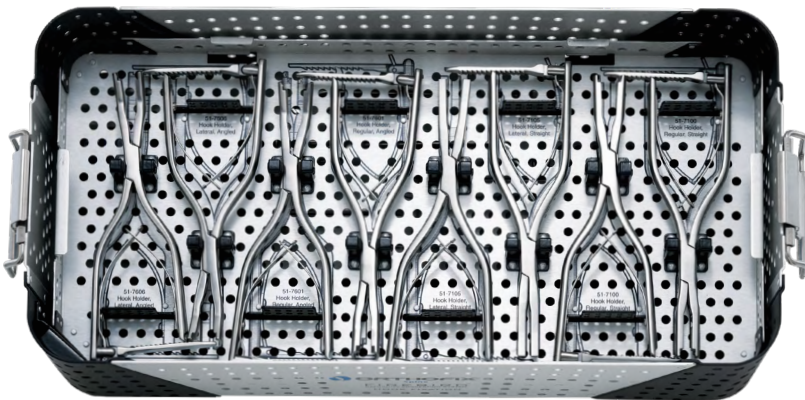



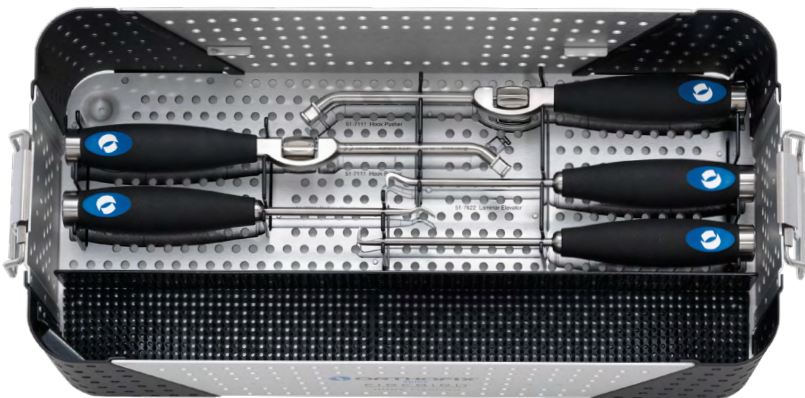





Hook Fixation Case
Level 2



Hook Fixation Case
Level 3

THORACIC FIXATION 51-9580

Implant/Instruments

	Part #	Description	Qty Set
	44-2001	Set Screw	30
	51-2450	450mm Rod, CoCr	4
	52-2450	450mm Rod, Ti	4
	51-1580	Hex Wrench	1
	51-1758	Set Screw Holder / Driver, Modular, Short	2
	51-1402	Bone Probe, Straight, Small	1
	51-1403	Bone Probe, Curved, Small	1
	51-1423	3.5mm Bone Tap, Modular	1

THORACIC FIXATION 51-9580

Implants







Bottom View

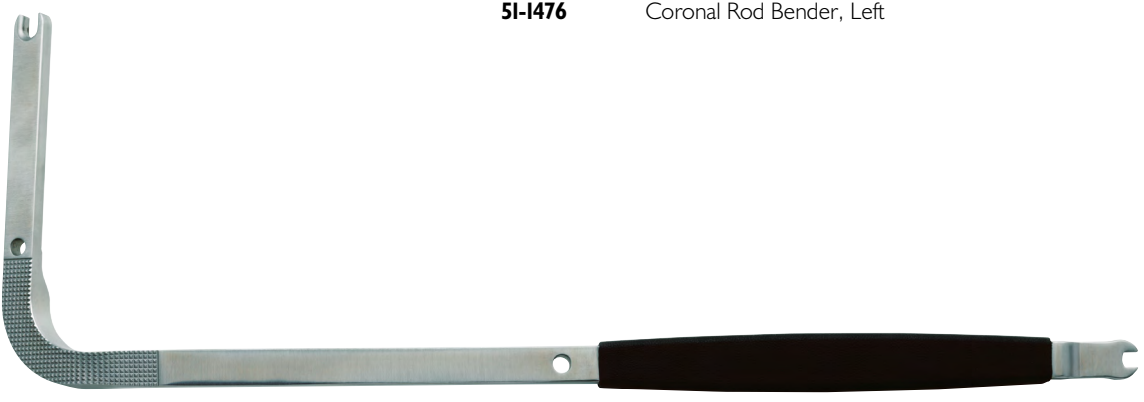

Part #	Description	Qty Set
51-3325	4.0mm x 25mm Uniplanar Screw, Self Tapping	6
51-3330	4.0mm x 30mm Uniplanar Screw, Self Tapping	6
51-3335	4.0mm x 35mm Uniplanar Screw, Self Tapping	6
51-3340	4.0mm x 40mm Uniplanar Screw, Self Tapping	6
51-3345	4.0mm x 45mm Uniplanar Screw, Self Tapping	6
51-3425	4.5mm x 25mm Uniplanar Screw, Self Tapping	6
51-3430	4.5mm x 30mm Uniplanar Screw, Self Tapping	6
51-3435	4.5mm x 35mm Uniplanar Screw, Self Tapping	6
51-3440	4.5mm x 40mm Uniplanar Screw, Self Tapping	6
51-3445	4.5mm x 45mm Uniplanar Screw, Self Tapping	6
51-3525	5.5mm x 25mm Uniplanar Screw, Self Tapping	6
51-3530	5.5mm x 30mm Uniplanar Screw, Self Tapping	6
51-3535	5.5mm x 35mm Uniplanar Screw, Self Tapping	6
51-3540	5.5mm x 40mm Uniplanar Screw, Self Tapping	6
51-3545	5.5mm x 45mm Uniplanar Screw, Self Tapping	6
51-3625	6.5mm x 25mm Uniplanar Screw, Self Tapping	6
51-3630	6.5mm x 30mm Uniplanar Screw, Self Tapping	6
51-3635	6.5mm x 35mm Uniplanar Screw, Self Tapping	6
51-3640	6.5mm x 40mm Uniplanar Screw, Self Tapping	6
51-3645	6.5mm x 45mm Uniplanar Screw, Self Tapping	6

THORACIC FIXATION 51-9580

Instruments

	Part #	Description	Qty Set
	51-1475	Coronal Rod Bender, Right	1
	51-1476	Coronal Rod Bender, Left	1
	51-1480	Rod Gripper	2
	52-1011	Ratcheting Handle, T-Handle	1
	52-1013	Ratcheting Handle, Straight, Small	1

THORACIC FIXATION 51-9580

Implant/Instrument Case

Part #	Description	Qty Set
51-0580	Thoracic Case	1



Thoracic Case
Level 1

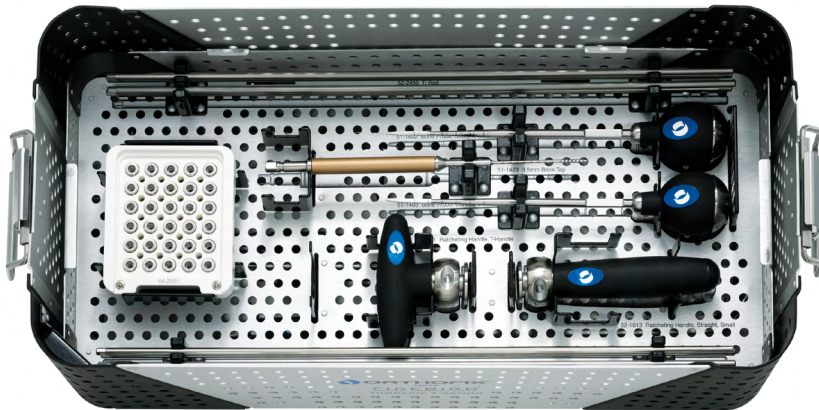



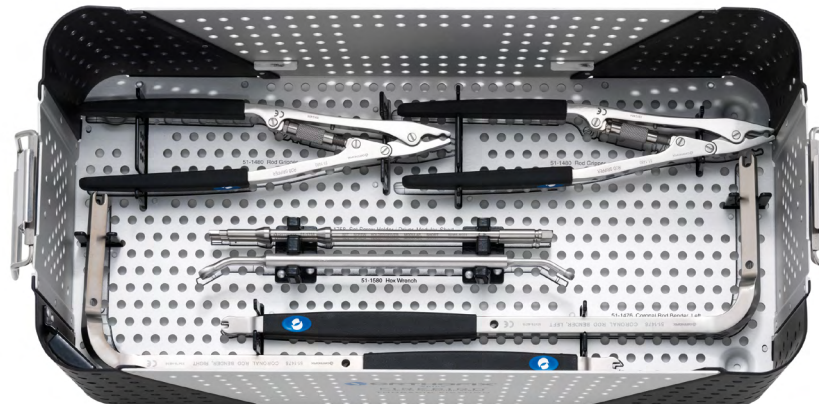

Thoracic Case
Level 2







Thoracic Case
Level 3

REDUCTION/ROTATION 51-9590

Instruments

	Part #	Description	Qty Set
	51-1455	Linear Rod Reducer	2
	51-1486	Rotation Handle	6
	51-1987	Ratcheting Connector, Large	6
	51-1988	Ratcheting Connector, Small	6
	51-1989	Tubular Rod Reducer	12

REDUCTION/ROTATION 51-9590

Instruments			
	Part #	Description	Qty Set
	51-1990	Driver, Tubular Rod Reducer	2
	51-1759	Set Screw Holder / Driver, Modular, Long	2
	52-1011	Ratcheting Handle, T Handle	1
	52-1013	Ratcheting Handle, Straight, Small	1

REDUCTION/ROTATION 51-9590

Implant/Instrument Case

Part #	Description	Qty Set
51-0590	Reduction Rotation Case	1

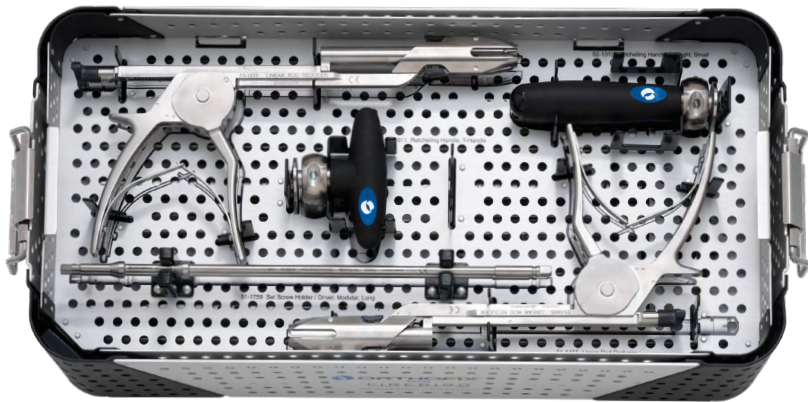

Reduction/Rotation Case
Level 1



Reduction/Rotation Case
Level 2

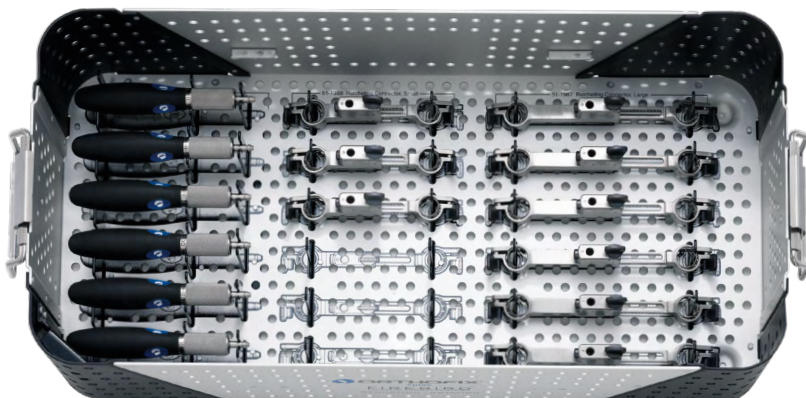

Reduction/Rotation Case
Level 3

Optional Instruments

Part #	Description	Qty Set
59-1041	In-Situ Rod Cutter	OPTIONAL
51-1020	10.5mm Bone Tap, Modular	OPTIONAL
51-1021	11.5mm Bone Tap, Modular	OPTIONAL
51-1220	10.5mm Bone Tap, Monolithic	OPTIONAL
51-1221	11.5mm Bone Tap, Monolithic	OPTIONAL
51-1227	7.5mm Bone Tap, Monolithic	OPTIONAL
51-1228	8.5mm Bone Tap, Monolithic	OPTIONAL
51-1229	9.5mm Bone Tap, Monolithic	OPTIONAL
51-1302	Iliac Bone Probe	OPTIONAL
52-1035	Rod Connector Insert	OPTIONAL

Optional Implants



Part #	Description	Qty Set
51-8030	Laminar Reduction Hook, Narrow, Small	REQ ONLY
51-8031	Laminar Reduction Hook, Narrow, Medium	REQ ONLY
51-8032	Laminar Reduction Hook, Narrow, Large	REQ ONLY
51-8040	Laminar Reduction Hook, Wide, Small	REQ ONLY
51-8041	Laminar Reduction Hook, Wide, Medium	REQ ONLY
51-8042	Laminar Reduction Hook, Wide, Large	REQ ONLY



51-8070	Pedicle Reduction Hook, Small	REQ ONLY
51-8071	Pedicle Reduction Hook, Medium	REQ ONLY
51-8072	Pedicle Reduction Hook, Large	REQ ONLY



51-8080	Thoracic Reduction Hook, Narrow, Small	REQ ONLY
51-8081	Thoracic Reduction Hook, Narrow, Medium	REQ ONLY
51-8090	Thoracic Reduction Hook, Wide, Small	REQ ONLY
51-8091	Thoracic Reduction Hook, Wide, Medium	REQ ONLY

Optional Implants

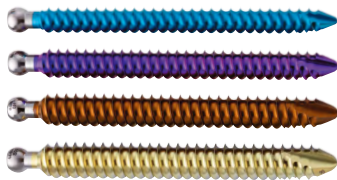

Part #	Description	Qty Set
44-5160	1 1.5mm x 60mm Bone Screw, Self Tapping	REQ ONLY
44-5170	1 1.5mm x 70mm Bone Screw, Self Tapping	REQ ONLY
44-5180	1 1.5mm x 80mm Bone Screw, Self Tapping	REQ ONLY
44-5190	1 1.5mm x 90mm Bone Screw, Self Tapping	REQ ONLY
44-5110	1 1.5mm x 100mm Bone Screw, Self Tapping	REQ ONLY



Mono-Axial Reduction Screws, Self Tapping

DIAMETER	25 mm - 95 mm	100 mm	110 mm
4.0 mm	61-73XX	61-7310	61-7311
4.5 mm	61-74XX	61-7410	61-7411
5.5 mm	61-75XX	61-7510	61-7511
6.5 mm	61-76XX	61-7610	61-7611
7.5 mm	61-77XX	61-7710	61-7711
8.5 mm	61-78XX	61-7810	61-7811

NOTE: Where XX refers to the length of the screw, ie: 61-7325 is a 4.0mm x 25mm Mono-Axial Reduction Screw, Self Tapping



Mono-Axial Screws, Self Tapping

DIAMETER	25 mm - 95 mm	100 mm	110 mm
4.0 mm	44-73XX	44-7310	44-7311
4.5 mm	44-74XX	44-7410	44-7411
5.5 mm	44-75XX	44-7510	44-7511
6.5 mm	44-76XX	44-7610	44-7611
7.5 mm	44-77XX	44-7710	44-7711
8.5 mm	44-78XX	44-7810	44-7811

NOTE: Where XX refers to the length of the screw, ie: 44-7325 is a 4.0mm x 25mm Mono-Axial Screw, Self Tapping



44-2103

Body, Reduction

Optional Implants

	Part #	Description
	55-5325	25mm, Cross Connector / Multi-Axial
	55-5330	30mm, Cross Connector / Multi-Axial
	55-5335	35mm, Cross Connector / Multi-Axial
	55-5340	40mm, Cross Connector / Multi-Axial
	55-5345	45mm, Cross Connector / Multi-Axial
	55-5350	50mm, Cross Connector / Multi-Axial
	55-5355	55mm, Cross Connector / Multi-Axial
	55-5360	60mm, Cross Connector / Multi-Axial
	55-5365	65mm, Cross Connector / Multi-Axial
	55-5370	70mm Cross Connector / Multi-Axial
	55-5375	75mm, Cross Connector / Multi-Axial
	55-5380	80mm, Cross Connector / Multi-Axial
	57-5315	15mm, Cross Connector / Fixed
	57-5317	17mm, Cross Connector / Fixed
	57-5319	19mm, Cross Connector / Fixed
	57-5321	21mm, Cross Connector / Fixed
	57-5323	23mm, Cross Connector / Fixed
	57-5325	25mm, Cross Connector / Fixed
	52-6701	5.5mm / 5.5mm, Rod Connector / Axial
	52-6801	5.5mm / 5.5mm F-F, Rod Connector / Parallel Front Loading
	52-6805	5.5mm / 5.5mm T-T, Rod Connector / Parallel Top Loading

Optional Implants



Bottom View



Uniplanar Screw, Self-Tapping

DIAMETER	50 mm - 95 mm	100 mm	110 mm
4.0 mm	5I-33XX	5I-33I0	5I-33II
4.5 mm	5I-34XX	5I-34I0	5I-34II
5.5 mm	5I-35XX	5I-35I0	5I-35II
6.5 mm	5I-36XX	5I-36I0	5I-36II

NOTE: Where XX refers to the length of the screw, ie: 6I-3350 is a 4.0mm x 50mm Uniplanar Screw, Self Tapping

Uniplanar Reduction Screw, Self-Tapping

DIAMETER	50 mm - 95 mm	100 mm	110 mm
4.0 mm	5I-43XX	5I-43I0	5I-43II
4.5 mm	5I-44XX	5I-44I0	5I-44II
5.5 mm	5I-45XX	5I-45I0	5I-45II
6.5 mm	5I-46XX	5I-46I0	5I-46II

NOTE: Where XX refers to the length of the screw, ie: 5I-4350 is a 4.0mm x 50mm Uniplanar Reduction Screw, Self Tapping



Please refer to the product “Instructions for Use” for full information on indications for use, contraindications, warnings, precautions and adverse reactions at orthofix.com/IFU

Caution: Federal law (USA) restricts this device to sale by or on the order of a physician. Proper surgical procedure is the responsibility of the medical professional. Operative techniques are furnished as an informative guideline. Each surgeon must evaluate the appropriateness of a technique based on his or her personal medical credentials and experience.



Orthofix
3451 Plano Parkway
Lewisville, Texas 75056-9453 USA
1.214.937.3199
1.888.298.5700
www.orthofix.com



Medical Device Safety Services (MDSS):
Schiffgraben 41
30175, Hannover
Germany
+49 511 6262 8630
www.mdss.com

Australian Sponsor
Emergo Australia
Level 20, Tower II
Darling Park
201 Sussex Street
Sydney, NSW 2000
Australia

Rx Only



Orthofix products or services referenced herein are trademarks or registered trademarks of Orthofix Medical Inc. and its group of companies. Any rights not expressly granted herein are reserved.

