

OSCAR



OSCAR

ULTRASONIC ARTHROPLASTY REVISION

CONTENTS

INTRODUCTION	3
THE EQUIPMENT	4
OPERATIVE TECHNIQUE	14
CEMENT REMOVAL	17
UNCEMENTED STEM REMOVAL	21
PROBLEMS AND SOLUTIONS	23

INTRODUCTION

The task of removing PMMA bone cement during revision arthroplasty has always posed a challenge to the surgical team. Difficulty in visualisation, ambiguity in discriminating between cement and bone and unpredictable scheduling all add to unnecessary complications and in the worst cases severely compromised bone stock and the need for expensive prostheses and other reconstructive materials.

Removing these unpredictable problems requires a device that can be relied upon to restore a planned schedule and outcome. Ultrasound, when applied correctly, can make the cement removal part of the operation predictable, safe and by definition more efficient and quicker.

PMMA bone cement responds instantly to a vibrating wave-guide. The putty-like consistency of the cement is then easily removed from the endosteum through novel design of the wave-guides (probes). Cancellous bone is affected by ultrasound and will be removed when subjected to the energy levels deployed during cement removal. Cortical bone will not be affected due to the probe design and the energy levels used. It does not absorb ultrasound as readily as the cement and therefore the surgeon will have awareness of the position of the probe within the bone through both audible and tactile feedback. It is important to refer to the operating techniques discussed later in this manual, because any tool is potentially dangerous if used contrary to the controlled methods described. The design of the probes is critical to safe cement removal; by always transferring the softened cement as the probe moves heat build up is not a major issue, provided irrigation is deployed according to the techniques outlined later. As technology has advanced control of the production of ultrasound, its delivery and monitoring, is now fully under digital circuitry.

OSCAR was introduced specifically to facilitate the removal of bone cement during hip revision procedures using ultrasound to soften the cement shell holding the implant in place. Special probes are deployed in a sequence to collect and remove the softened cement from the host bone. The technique reduces manual force to a minimum and practically eliminates the risk of bone fracture and perforation. The technology has become accepted as the standard means of joint revision where cement fixation is involved.

Ultrasound and the Removal of Bone Cement

Ultrasound is the name given to high frequency vibrations (above 16 kHz) which travel through air, liquid or solid media as pressure and displacement waves. In a bounded system, standing waves may be established, which produce a much greater concentration of acoustic energy, and scope for rapid local heating at absorption sites. Attempts were made

at the Endo Clinic in Hamburg in the early 1970's to remove bone cement by melting it with ultrasound. Bone cement is remarkable in that it can maintain a temperature gradient of 200o over a distance of 1mm. This means that if molten cement can be removed rapidly, the residual cement hardly increases in temperature, thus minimising damage to adjacent bone. In the initial studies in Hamburg, however, it was found difficult to remove the molten cement. The technology is now available to do this, using a series of specially designed handsets and probes in conjunction with a portable ultrasonic generator ("OSCAR" System for Cemented Arthroplasty Revision). Animal studies have demonstrated that when the tip of the probe is in contact with the endosteal bone surface for a period of 10 seconds, cell death to a depth of only 50 microns occurs. This contrasts with cell death to a depth of 500 microns, which occurs when conventional PMMA is applied to the endosteal surface.

Cement removal using this technique is extremely rapid, and can normally be accomplished in 25 minutes or less. The risk of bone perforation or fracture is negligible when OSCAR is used, as the probes are designed to emit a characteristic sound the moment they come into contact with the bone surface. The equipment is simple to operate, and both efficient and predictable in its performance. It has been designed with surgeons, scrub nurses, technicians and hospital engineers in mind and its use permits the accurate scheduling of theatre lists.

Cementless Prosthesis Revision

Over the last 15 years total joint surgery has moved, in some countries, away from cemented fixation to the use of press-fit prostheses. These are normally either porous or hydroxyapatite coated stems and acetabular shells, which encourage bony in-growth to provide fixation and stability. Inevitably, a percentage of these will require revision and the specific task of separating the implant from the bone will require osteotomes and burrs leading to a complex and potentially damaging procedure.

Precedents exist for the use of ultrasound powered osteotomes and adding this function to the OSCAR system was a natural extension of the intended use in order to cater for the changing needs in arthroplasty revision surgery. Ultrasound remains one of the most effective and safe energy forms available for powering surgical instruments. By careful design of the oscillatory system, collateral damage due to local heating can be minimized to levels significantly below that associated with high speed burrs and oscillating saws. Low force cutting coupled with precise control of energy delivery to the operating site, ensure that ultrasonically powered osteotomes will answer surgical needs in growing demand for revision arthroplasty.

THE EQUIPMENT

The OSCAR 3 system is comprised of a portable generator which has 2 output channels. Both channels 1 and 2 drive standard OSCAR cement removal handsets or OSCAR osteotome handsets. The channels can be activated via an air footswitch or via the handset switches.

There is also a large range of cement removal probes, prosthesis removal probes, and a dedicated cleaning system.

The Generator

The generator is mains powered and completely portable. It consists of an integrated power supply unit, enabling the generator to be powered from 240Vac mains, a control circuit, 2 power circuits and an LCD. The control circuit controls the 2 power circuits. A block diagram of the electrical system is shown in (Figure 1).

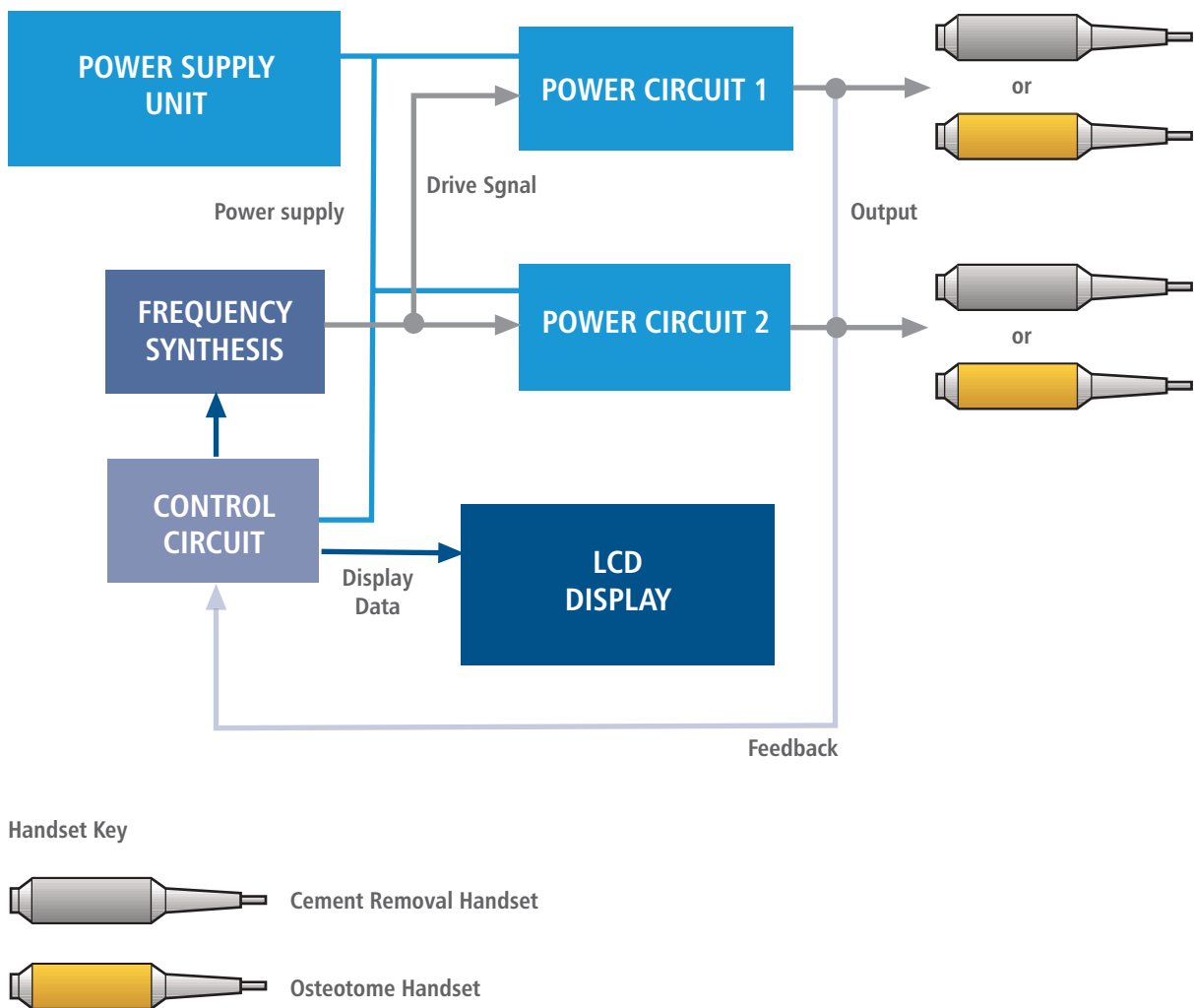

Figure 1 - OSCAR 3 Generator overview

The two channel outputs running the handsets are microprocessor controlled and are designed to produce ultrasonic energy at the resonant frequency of the attached handset. The frequency range is 27.9 to 28.5 kilohertz.

Careful control of the generator output ensures that the energy delivered to the handsets increases automatically in response to the increased load. In effect, as a probe is pushed into bone cement, (or bone for osteotomes) more energy is supplied to the handset - ranging from a few watts to a 150-watt output. In practice, the peak loads do not exceed 130 Watts when piercing solid cement or cutting bone.

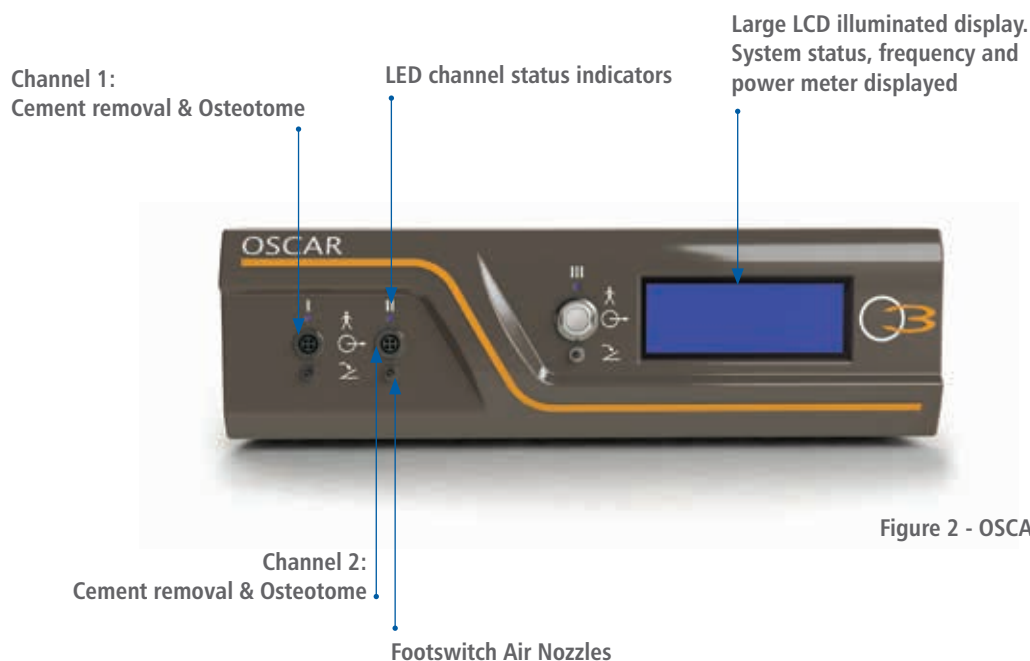

Figure 2 - OSCAR 3 Front panel

Once connected to the mains supply, the generator (**Figure 2**) is activated by the ON/OFF switch at the back on the LCD side of the enclosure. Both of the output channels have a 4 way socket for connection of OSCAR cables, which in turn connect to cement removal or osteotome handsets. Each channel also has an air nozzle socket, positioned below each output socket. The footswitch tubing connects to these air nozzles.

The Handsets

Cement Removal Handset

Each handset contains a piezo-ceramic sandwich transducer - the ultrasonic "motor", and a mechanical focusing device - the "horn" (B). These are enclosed in a water and pressure tight stainless steel casing which incorporates a small hand operated switch (A). This switch when depressed once and held will operate the handset; a click will be felt. The electrical connection is at the rear end of the handset (C). The shroud and end cap (D & E) are removed from the handset prior to autoclaving.

A variety of probes may be fitted to the output end of the horn via a screwed coupling, and these permit the surgeon to carry out a range of procedures with maximum efficiency. Each probe consists of a waveguide, which is an integral number of half wave lengths long, its shape and overall length being chosen to suit a particular case.

The signal from the generator induces the crystals within the handset to vibrate, producing ultrasonic energy. This energy is focused along the wave guide to the tip of the probe, which will vibrate at approximately 28.3 kHz. The rapid oscillatory movement produces heat when the tip of the probe is in contact with bone cement, causing the cement to liquefy almost immediately.

Osteotome Handset

In order to cut both cortical and cancellous bone the transducer which is used to generate axial vibration in the OSCAR handset has been redesigned so that its output impedance is compatible with bone tissue. This results in reduced displacement amplitude and the ability to sustain a higher distal load. Bone cutting handsets are identified by their gold outer sleeve case and larger size connecting thread at the output end. (See Figure 4 below).

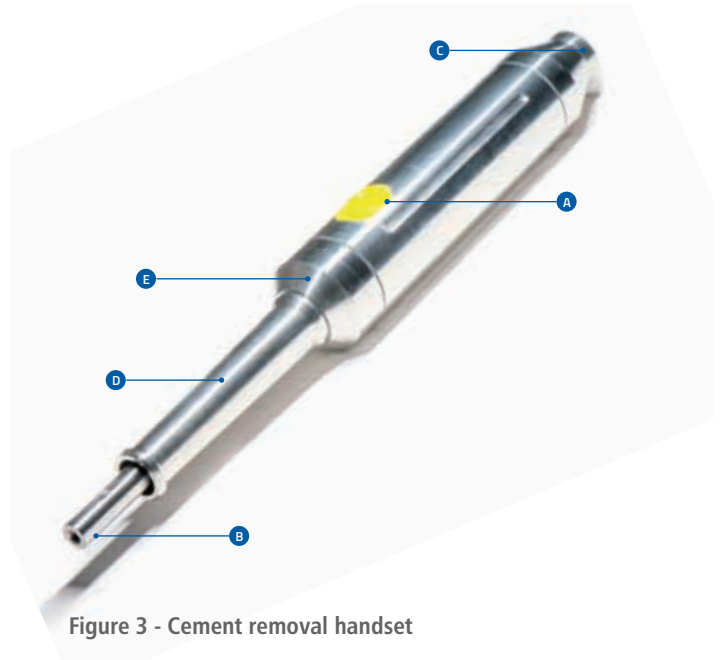

Figure 3 - Cement removal handset



Figure 4 - Osteotome handset

The Probes

All the probes in the OSCAR system are detachable from the main handsets. There are a multitude of probes available. Each handset type has its own range of unique probes. Each probe is attached to the main handset via a screw threaded connection. Once connected correctly the probe acts as a waveguide, focusing and directing the ultrasound energy generated within the handset to the probe tip or blade, enabling the handset to perform the task at hand, be it removal of bone cement or bone cutting.

Cement Removal

The cement removal probes are for use with the Cement Removal Handset. (See Figure 3).

The Cement Removal Handset can be run from either Channel I or II of the OSCAR 3 generator.

There are many different cement removal probe designs. All probes are made of a titanium alloy, and screw into the distal part of the horn. They are tightened using the supplied 9mm spanner unless otherwise specified. Each probe is designed to perform a different function, grooving, scraping, piercing or cutting. Those probes designed to cut through regions of compact cement have heads incorporating two or more perforations or grooves. Friction between the bone cement and the high velocity tip surface of the ultrasonic probe causes rapid heating at points of contact. A small volume of cement melts, and under the advancing impetus of the probe tip this molten cement is forced through the ports in the head, or the grooves in the body solidifying behind it when the ultrasonic energy is turned off.

Smoke is generated during the procedure. The dominant components are methylmethacrylate, benzene and styrene. All concentrations produced are well below OES/MEL values. (OES = occupational exposure standards, MEL = maximum exposure limits).

Once broken up in this way, the cement can readily be removed, either by withdrawing the probe with adhering cement or using conventional instruments.

Probes designed solely for scraping material from the endosteal surface of the bone are not equipped with perforations in the probe head. A description of individual probe designs follows.

Consumable Probes

Do not allow any consumable probe to come into contact with a metal surface whilst active, as this will cause damage to the probe.

Consumable probes are reusable, however they will wear and become damaged after a number of uses. The number of uses varies depending on type and duration of use.

As further probes are developed their status will be made clear as to whether they are re-usable (consumable) or single use.

The Groover

OHG2020 (Consumable)

The groover (**Figure 5**) has a flattened spear-shaped head with one hole on each side, and a forward cutting blade at the most lateral aspect of the device.

The groover is used primarily to cut longitudinal channels in the proximal cement mantle, in order to weaken the integral cement mass and permit segmental removal with conventional instruments. When the groover comes into contact with bone, a high pitched squeaking noise is heard, and resistance encountered. Note: this squeaking is a reaction between the probe and the bone and not generated from the module. This audible feedback cannot be relied upon if the bone is osteoporotic, dead or if some residual cement is still present to dampen the sound.



Figure 5 - The groover probe

The Axisymmetric Reverse Scraper

OHS2061, OHS2081, OHS2100 (Consumable)

The scraper (**Figure 6**) is spear shaped, with no perforations within the head and is supplied with three tip diameters, 6mm, 8mm and 10mm.

Note: the 10mm scraper has a short wave guide. The cutting edge is machined at an angle of 20 degrees to the axis of the probe, and it is used for removing well bonded proximal or distal cement and membrane from the endosteal surface by applying a reverse scraping action.



Figure 6 - Scraper probes

Piercers

OHP2061, OHP2081, OHP2100, OHP2101,
OHP2111, OHP2131 (Consumable)

The piercer is a round, spear shaped device with 4 perforations in the head and is used for fenestrating the distal plug of cement to provide a clear channel, which can then be enlarged using the long scraper. The piercer is supplied in various tip diameters ranging from 6mm to 13mm (Figure 7). When the piercer strikes cortical bone there is a high pitched audible squeaking noise and resistance is felt.

It should be noted that the piercer will de tune when it is in contact with bone, unless it is circumferentially compressed by bone, when de tuning will not occur but resistance will be felt and no smoke will be generated.



Figure 7 - Piercer probes

The Acetabular Probe

OHA2030 (Consumable)

The Acetabular probe (Figure 8) is used to assist in the removal of the acetabular cup. It is important to remember that when using OSCAR, none of the activated instruments should be allowed to make contact with metallic components; this is particularly relevant when considering its application to the acetabular cup.



Figure 8 - Acetabular probe

Single Use Probes

Single use probes should not be reprocessed under any circumstances.

The Single Use Piercer OHP2080SU (Disposable)

The piercer (Figure 9) loses its cutting edge over time in the same way as the axisymmetric reverse scraper. In response to customer feedback, Orthofix supplies a single use piercer probe. The single use probe has an SU in its batch number etched onto its' side to distinguish it from the reusable probe. In addition the wording 'single use' is etched onto the shaft. This probe also differs from the consumable piercers by being 1/2 wave-length, and requiring a 7mm spanner for fixation. It is extended using special extension bars, OHE2001SU and OHE2000SU, long and short respectively, and although they have the designation SU at the end of the identification, this does not signify they are single use. There is no wording 'single use' on the shaft.



Figure 9 - Single use piercer probe

The Single Use Axisymmetric Reverse Scraper OHS2080SU (Disposable)

Over time the cutting edge of the scraper probe loses its sharpness. Many customers expressed an interest in a cheaper, disposable probe that can be discarded after a single use so as to provide optimum cutting ability at all times. In response to this request Orthofix supplies a single use axisymmetric reverse scraper (Figure 10). Its size and mass are much reduced from the reusable probes, making them cheaper to purchase. The single use probe has an SU in its batch number etched onto its' side to distinguish it from the reusable probe. In addition the wording 'single use' is etched onto the shaft. It is designed to be used with the special extension bars, OHE2001SU and OHE2000SU, long and short respectively, and although they have the designation SU at the end of the identification, this does not signify they are single use. There is no wording 'single use' on the shaft.



Figure 10 - Single use reverse scraper probe

**The Slim Shafted Piercer
(OHP2062SU)
and Scraper
(OHS2062SU) (Disposable)**

Upper limb revision surgery involves removing cement from the thinner cortices and narrower medullae of the ulna and humerus. Two probes, one piercer and one scraper (**Figure 11**) each with a 6mm head, are available with 4mm shanks to allow good access. Due to the fragile nature of the slim shank these probes have been designated single use.

Their clinical use is similar to the femoral piercers and scrapers, however, in accordance with safety instructions already mentioned, increased frequency of irrigation should be used when removing cement from the humerus and ulna.



Figure 11 - Slim shafted piercer probe / scraper probe

**Inertial Probe Loading Instrument
(Slaphammer) IPL200 (Consumable) and
Extraction Probe EXP2681SU (Disposable)**

This extraction probe (**Figure 12**) is designed to remove larger pieces of cement and the cement plug. However, the deployment of this probe is to be undertaken with care because the technique relies on the probe being embedded in cement, which is allowed to solidify. Instructions for use are located in the Surgical Technique section of this manual.



Figure 12 - Extraction probe
Figure 13 - Slaphammer

Osteotome Probes

The osteotome probes are classed as SINGLE USE. They are for use with the osteotome handset (See Figure 4). Osteotome handsets can be run from Channels I & II of the OSCAR 3 generator. After use, the Osteotome probes should be disposed of as per normal operating room procedures, ideally in a suitably sized sharps container.

Uncemented Stem Removal

Fixation of uncemented stems is achieved by creating a porous coating on the implant or by adding hydroxyapatite to selected portions of the surface, both of which encourage bony ingrowth and generation of new cancellous bone. When revision is necessary, the implant is removed by cutting through what is a substantially cancellous bone interface surrounding the stem. This is done using a variety of flat, narrow osteotomes coupled to the specially designed osteotome handset. The essential feature of the osteotomes is a series of edge serrations forming a saw blade. The osteotomes are introduced beside the prosthesis stem to form a series of extended slots which effectively isolate the implant from the host bone. In some cases it may be necessary to cut into cortical bone when the depth of cancellous bone is limited.

Hoe Probe

6mm OHH2062SU (Disposable)
8mm OHH2081SU (Disposable)

This probe (Figure 17) is designed to remove small pieces of cement during upper extremity revisions. Similar to the reverse scraper, the hoe probe is used in a back scraping motion to remove cement in narrow canals.

Flat Serrated Osteotome Probe (Disposable) Figure 14

Flat Non Serrated Osteotome Probe (Disposable) Figure 15

Curved Serrated Osteotome Probe (Disposable) Figure 16



Figure 14 - Flat
Figure 15 - Flat non - serrated osteotome probe
Figure 16 - Curved serrated osteotome probe

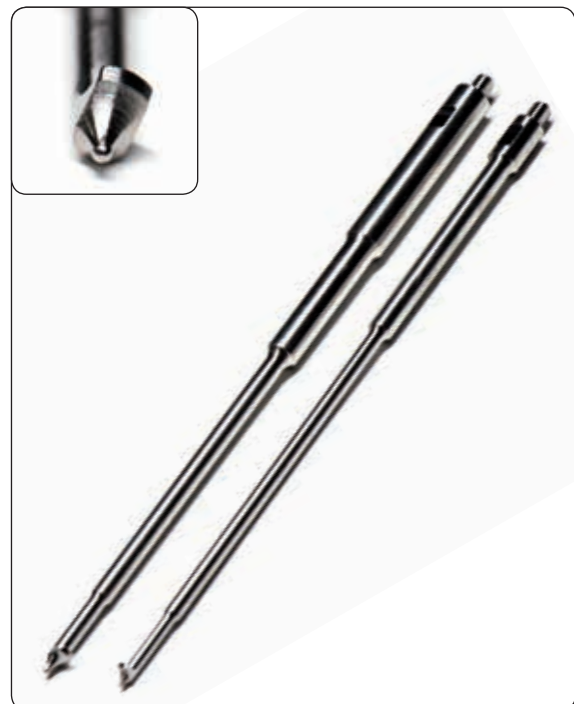

Figure 17 - Hoe probes

The Cables

(For use with Cement Removal and Osteotome Handsets)

Silicone rubber cables with screened conduction wires are supplied with the equipment to connect the handsets to the generator. Each cable contains 2 separate ground leads for safety reasons. This means in effect, that the patient will be grounded when in contact with the device and this may cause hospital diathermy equipment to alarm and cease functioning, as this apparatus will not work when the patient is grounded.

(Action: turn off the diathermy machine while OSCAR is being used)

The sterile cable (**Figure 18**) is connected to the front of the generator, into channel I or II, by aligning the red dot on the end of the cable with the red dot on the generator input sockets. Once aligned the cable is then inserted until a small click is heard. The cable must be held by the boot when connecting. The same procedure is used to connect the cable to the handset. Please note the cables are interchangeable, it does not matter which end goes into the handset or generator. To remove the cable the grooved metal sleeve of the connector must be pulled backwards.



Figure 18 - Handset cable

Footswitch

A double air footswitch (**Figure 19**) can be used on either of the output channels on the OSCAR 3 generator. Channels I & II utilise cement removal and osteotome handsets, which both have handset mounted switches, but can also be operated from the attached footswitch.



Figure 19 - Footswitch

OPERATIVE TECHNIQUE

Setting Up

Taking the required handsets (see **Figure 3 & Figure 4**), attach the required probes to the handset horn as shown in (**Figure 20**) seen opposite. Attach the required probe to the handset horn using suitable sterilised spanners. One on the handset horn and one on the probe. Do not use a single spanner to attach the probe as this may damage the handset.



Figure 20 - Attaching a probe to the handset

Connect the handset to either channel on the front panel of the generator. To connect the handset cable, line up the red dots on the cable connector and generator/handset connector and push. The connector will click into place (to disconnect pull on the front grooved part of the connector). If footswitch activation is required then connect the air tubes (note colour coding) from the footswitch to the relevant air nozzle on the front panel to channel I or II. (See **Figure 21**).

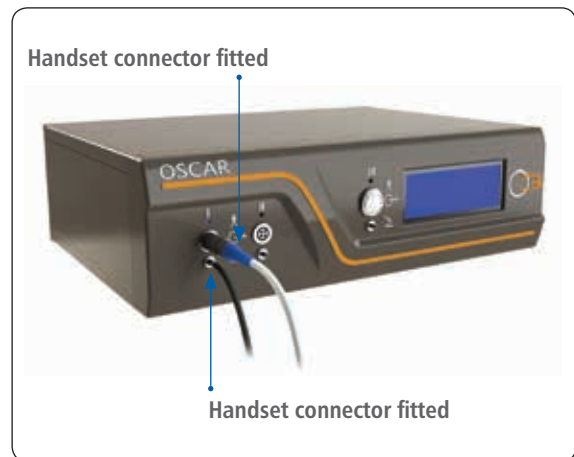

Figure 21 - Channel I set up

First ensure that the device is plugged into mains voltage and that the switch on the back of the machine is in the 'ON' position.

When the generator is first switched on, the LCD will display **SELECT A CHANNEL**. In order to select the required channel, simply depress the required handset switch or footswitch once on cement removal or osteotome handsets. Once selected, the generator will sound a beep and the appropriate channel LED will illuminate. The LCD will display which type of handset has been selected. (See **Figure 22**).

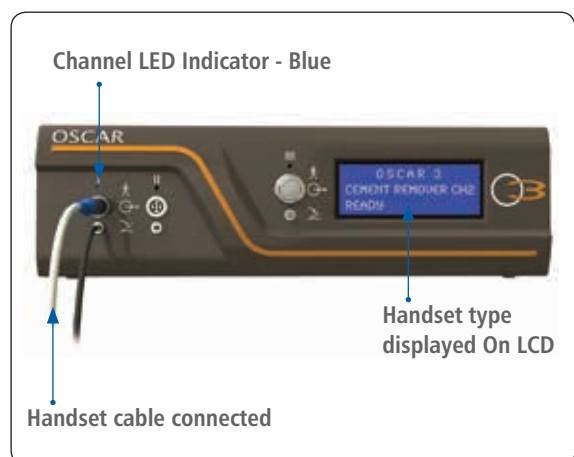

Figure 22 - LED - Channel ready

To activate the selected channel, press and hold either the handset switch or footswitch. When activated the relevant channel LED will turn yellow and the sounder will activate. The handset will tune to its resonant frequency. Only one channel can be active at any one time. To change channels, connect appropriate handset and depress the hand/foot switch once.

The generator will now tune the handset to its resonant frequency every time the handset is operated. When the handset is activated the LED for that channel will turn yellow and the sounder will beep on / off as long as the handset is active. The frequency is displayed and the power bar graph indicates power delivery to handset. A countdown timer will commence from the moment the handset activates. (Maximum ON time is 30 seconds). When the countdown timer approaches zero, the sounder pitch will rise.

The handsets will feel silky when light pressure is applied to the attached probe. **It is most important not to squeeze the probe**, as this will cause a friction burn to the tissues. It is equally important not to allow the probe to come into firm contact with the patient's skin or muscle during operation. The shroud allows the surgeon to hold the handset with both hands in a comfortable and controllable manner. The patient's tissue should be protected using a dry swab. As pressure is exerted on the handset the power output will increase and this is displayed via the power bargraph. If too much pressure is exerted, the cutting performance will decrease and an alarm will sound. This will occur when the power bargraph is on full deflection to the right. As the pressure on the handset relaxes the alarm will cease and cutting performance will improve.

The Display

The LCD will display the handset frequency, the time left for activation in second and a power bargraph, illustrating loading of the handset. (As the mechanical load on the handset / probe is increased, the power delivered to the handset increases). With no load applied, ie, with the handset running in air, the bargraph should display one or two illuminated rectangles. This is not an instrument to measure the power. It is only for indication for the user.



Figure 23 - LED - Channel active

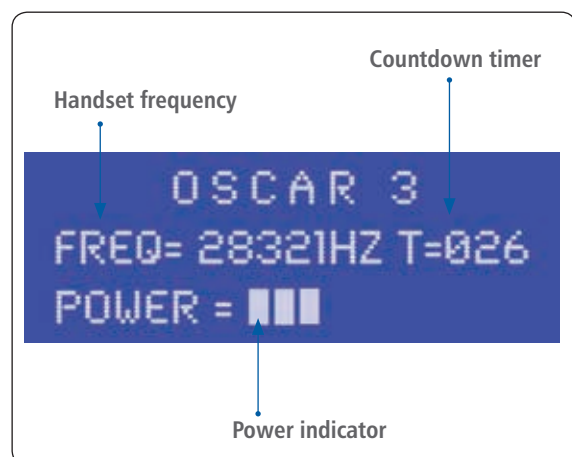

Figure 24 - LED - Channel ready

Each channel LED indicator has the following meaning:

- Blue indicator illuminates when channel is selected.
- Yellow indicator illuminates when handset is active.

HANDSET NOT DETECTED	The handset type cannot be read by the generator. Return the handset for service.
POOR FEEDBACK RELEASE ALL SWITCHES	This means too much pressure has been exerted on the handset as the handset is switched on. The channel will automatically reset after 4 secs. If this message repeatedly occurs even when running the handset in air, it is likely that the probe has fatigued and should be replaced. If the message remains then the handset has failed.
ERROR NO LOCK	This means the generator could not find a handset resonance in the correct frequency range. The generator will automatically reset.
OVERTEMP	This means the power devices within the channel power circuit have become too hot and to avoid damage the channel has shut down. The devices may overheat through extended periods of heavy loading. Allow the channel power circuit to cool for several minutes. The generator will reset the channel. If the 'overtemp' message continues even after 10minutes have passed, and repeated resets do not clear the message, then the power devices may have failed on that channel output.
FREQUENCY TOO LOW	When the handset is running it will naturally warm up and its resonant frequency will drop. After prolonged periods of use the frequency may drift out of the usable range. Allow the handset to cool.
ACTIVE TOO LONG	The countdown timer has timed out...the maximum time the handset can be run continuously is 30 seconds. This is to guard against the power devices overheating.
CEMENT RELEASE MODE	This is most likely to occur when a piercer is being used. If the tip of the piercer is pushed too deeply into the cement and allowed to remain in situ, then the cement behind the tip is liable to solidify and trap the probe. If this happens, the load on the probe may be excessive preventing normal resonance because of the mass of cement now attached to the probe. If this occurs the generator will automatically enter a 'stuck in cement' mode and display CEMENT RELEASE MODE

Energise the handset, but do not apply any pressure on the handset for the first 2 seconds of use (this gives the channel a better chance to find a resonant feature). The generator will perform repeated scans of the handset, sounding a double beep as it does so. Whilst this occurs, gently remove the probe from the cement. When free from cement the channel mode will return to normal operation.

This procedure may lead to an OVER-TEMPERATURE message on the LCD. Allow the channel to cool for several minutes. When the channel resets attempt removal again. This process may take a couple of attempts, depending how deep the probe is stuck in the cement.

Should an individual channel fail for any reason, the remaining channels will remain operational. When convenient return the system for servicing to Orthofix Srl.

Probe Use

CEMENT REMOVAL

The following description relates to hip surgery but is equally applicable to other forms of revision Arthroplasty. It is essential that the patient be placed on his/her side to facilitate cement removal. Following removal of the femoral component it is important to have adequate access to the cement. To this end it is worthwhile removing bone from the upper portion of the greater trochanter to allow straight access to the cement within the femoral canal.

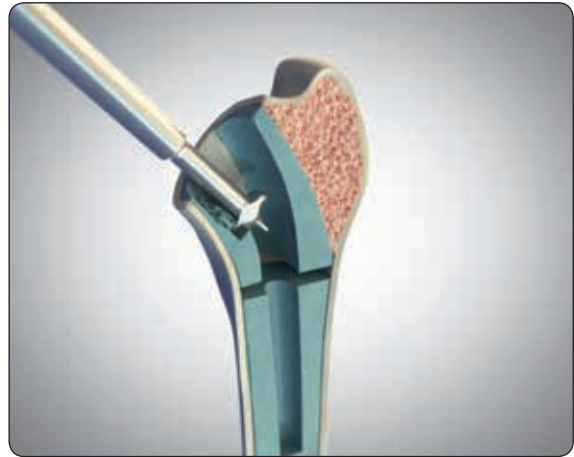

Removal of the Proximal Cement Mantle

The proximal cement in the upper third of the shaft is usually loose, with a membrane between it and the bone. This cement can be removed simply, using the groover to cut longitudinal channels through it. When the cutting edge of the groover is placed in contact with the cement, the friction generated by the ultrasonic beam will heat up the cement, which softens and extrudes through the holes in the side flanges (Figure 25). The groover is then pushed gently down the femoral canal in contact with bone to remove a trough of cement. This trough can be extended within the femoral canal as far as the groover can go.

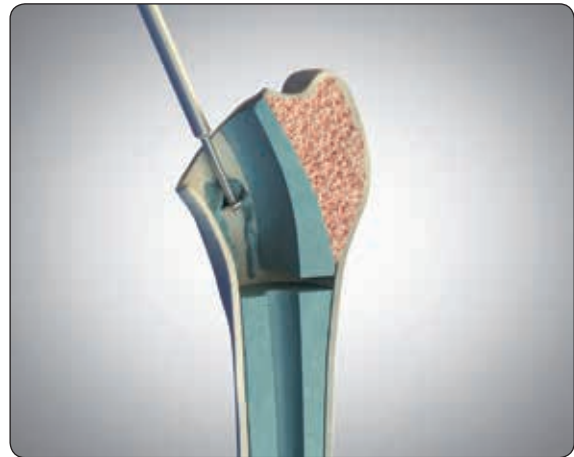

It is usual to make 3 longitudinal troughs within the cement at approximately 120-degree intervals. The amount of force required is similar to that needed push a knife through hard butter.

Once the 3 longitudinal grooves have been made, it is necessary to make circumferential grooves at approximately 1.5 to 2 cm intervals down the cement mantle. This can be done using either the groover or a back scraper. The fragments of bone cement can then be folded into the medulla and removed with forceps. The proximal cement is removed incrementally, using this technique, down to the level of the cement plug.



Figure 25 - Removal of proximal cement mantle

Removal of Well Bonded Cement and Residual Membrane

Any residual well bonded cement which remains after removal of the proximal cement mantle, and the fibrous membrane which is usually adherent to the endosteal surface, may be removed using the axisymmetric reverse scraper (back scraper).

The back scraper cuts by focusing ultrasonic energy on to the retroverted cutting edge at the back of its spear shaped tip. The scraper can also be used to remove the proximal cement if the mantle is too thin for the groove.

The cutting edge is put into contact with the cement or the membrane and withdrawn with a moderate amount of force for removing cement, or just gentle pressure for removing the membrane. The membrane will peel off in strips leaving a raw cancellous surface which is ideal for bone grafting should this be required.

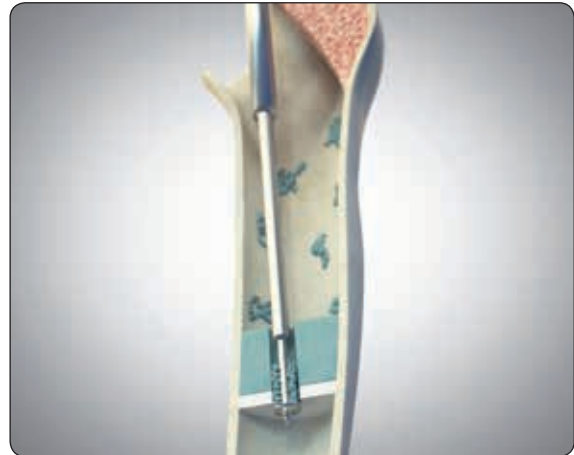

Figure 26

Removal of the Cement Plug

Removal of the cement plug is performed using the piercer. The piercer focuses ultrasound to the very tip of its spear shaped head causing the cement to liquefy at the point of contact. The liquid cement then flows backwards through the perforations in the head and solidifies behind it.

The piercer is gently pushed into the cement plug, and after advancing it for between 1.5 and 2 cm the switch on the handset is released and the handset is removed 1 or 2 seconds later. This short period of time allows the cement to solidify behind the flange for most efficient removal.

(Figures 26 & 27). If the piercer is pushed with too much force, the energy at the tip will reduce and the system will work less efficiently.

The cement removed using the piercer can be simply wiped from the waveguide using a wet swab, after each application. Should the tip of the piercer come in contact with bone, the waveguide will de tune slightly and produce an audible high pitched squeaking noise. Resistance will be felt and the volume of smoke generated will diminish.



Figure 27

Removal of the Cement from the Distal Femur

Once the plug has been perforated, it is necessary to remove the cement that is in contact with the distal femur and this can be done either with the groover or, if the femur is too narrow, with a long back scraper. (Figure 28a - 28b)

There is sometimes a polythene cement restrictor distal to the cement plug. The ultrasonic device will cut through polythene, but it does so at a slower rate than when cutting through bone cement.

In these circumstances it is necessary to wait for a few seconds before advancing the probe, as polyethylene absorbs more ultrasonic energy than polymethylmethacrylate.

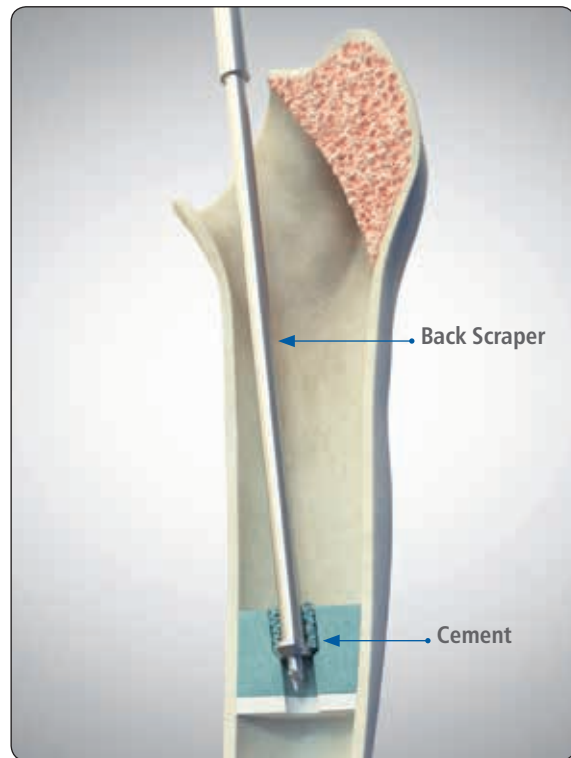

Figure 28a

Use of Extraction Probe

For rapid removal of the cement plug and under certain conditions, the OSCAR system incorporates an extraction probe and slap hammer. The extraction probe, like the piercer probes, is designed to penetrate the cement in a forward motion. The surgeon sinks the probe into the plug up to a reasonable depth and then rotates the probe and handset 90 degrees.

By removing the power and holding the probe insitu in the canal for 30 seconds, the cement re-hardens around the probe. The handset can then be detached and the slap hammer connected. Do not place excessive force on the slap hammer when in use.

X-rays will give good indication of when the extraction probe can be used. Ensure that there is good bone stock, delamination of the cement, an even tapered canal, and the cement lies above any isthmus. Incorrect positioning of the probe can easily lead to bone fracture, or other damage within the canal.

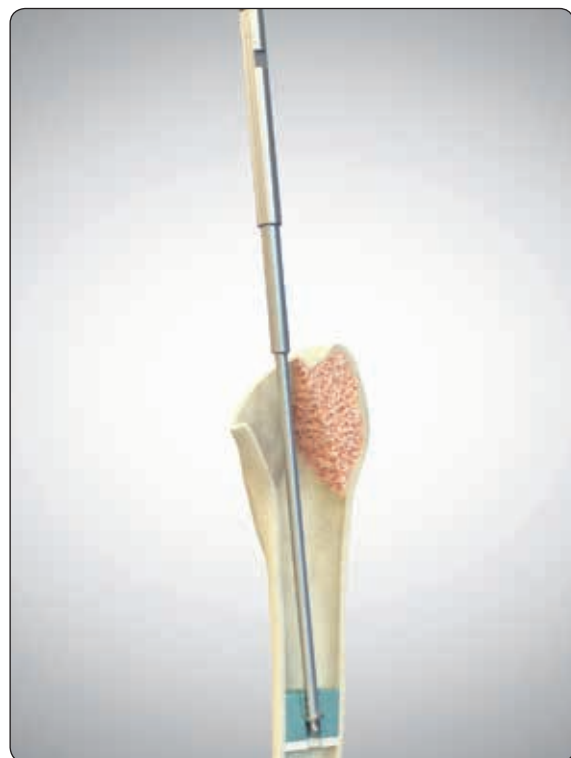

Figure 28b

Removal of Cement from the Acetabular Cup

It is important to remember that when using OSCAR, none of the activated instruments should be allowed to make contact with metallic components; this is particularly relevant when considering its application to the acetabular cup.

By reference to the x-rays, identify and locate all metallic parts associated with the prosthesis. The acetabular probe can be used to remove cement posterior to the cup by making a series of curved slots extending from the exposed circular profile towards the centre of the cemented hemispherical surface (Figure 29).

Four or five slots should be sufficient to loosen the acetabular component, which may then be removed by careful use of a cement chisel.

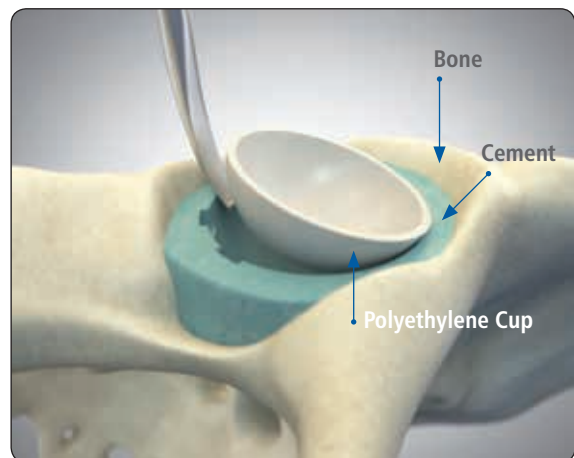

Figure 29: Removal of cement from acetabular cup

UNCEMENTED STEM REMOVAL

Fixation of uncemented stems is achieved by creating a porous coating on the implant or by adding hydroxyapatite to selected portions of the surface, both of which encourage bony ingrowth and generation of new cancellous bone; when revision is necessary the implant is removed by cutting through what is a substantially cancellous bone interface surrounding the stem. This is done using a variety of flat, narrow osteotomes coupled to the specially designed bone cutting handset. The essential feature of the osteotomes is a series of edge serrations forming a saw blade. The osteotomes are introduced beside the prosthetic stem to form a series of extended slots which effectively isolate the implant from the host bone. In some cases it may be necessary to cut into cortical bone when the depth of cancellous bone is limited.

Irrigation During Cementless Revision

It is important to maintain a steady flow of saline around the prosthetic stem during insertion of the flat osteotomes, particularly when cutting cortical bone. This ensures that the metal on metal interface is kept cool and lubricated whilst the active edges of the osteotome are cutting bone. Ovine studies indicate that even without coolant only minimal damage is likely to occur at the cut interface providing that energised sequences are limited to 5-10 seconds. With cooling the full 30 second active sequence allowed by the generator control system is safe.

Please note: All osteotome probes for use with the gold osteotome handsets, are fitted with M6 threaded spigots so that they cannot be used in error with the standard cement removal handsets, which have M5 threads.

Acetabular Cup Removal

The curved serrated osteotome (See Figure 16) probe is used in a similar fashion as the cemented version Acetabular probe. The probe is first used to create slots around the circumference of the cup. Once the slots are created, the probe can be used in a lateral motion to cut the remaining bony ingrowth interface. It is important to remember to activate the probe before advancing into a previously created slot and to not create manual pressure before activating the probe. Doing so may lead to the probe improperly tuning and possibly breaking during use.

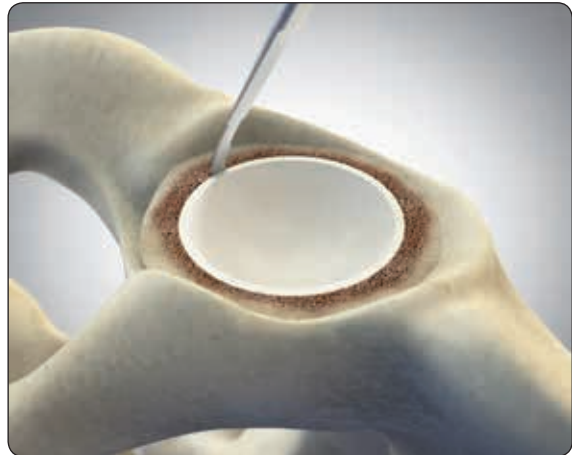

Figure 30 - Acetabular cup removal

Tibial & Femoral Component Extraction

The steps in removing the knee components with the OSCAR bone cutting probes are similar to the stem extraction steps in hip revisions. The 6mm flat osteotome probe is used to penetrate the interface and create slots under the prosthesis. The 6mm flat serrated probe can then be used laterally to break the remaining bond between bone and prosthesis. Again, the high-pitched noise will be created by the active probe being in contact with the prosthesis. It is important to not use heavy manual force when this noise is present and to continually use irrigation while the probe is active. The OSCAR osteotome probes can greatly assist in the conservation of bone. By being a space creating tool, no wedging or forcing is needed; leading to less stress to the surrounding bone. With OSCAR, no levering motion is needed nor should be used, as levering can lead to more bone loss than desired.

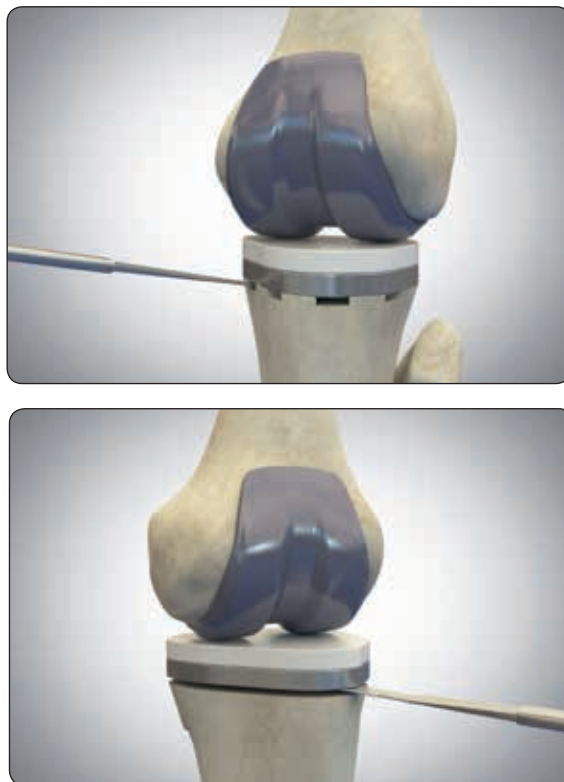

Figure 31 - Tibial & femoral component extraction

Stem Extraction from the Femur

The steps in removing the knee components with the OSCAR osteotome probes are similar to the stem extraction steps in hip revisions. The 6mm flat osteotome probe is used to penetrate the interface and create slots under the prosthesis. The 6mm flat serrated probe can then be used laterally to break the remaining bond between bone and prosthesis. Again, the high-pitched noise will be created by the active probe being in contact with the prosthesis. It is important to not use heavy manual force when this noise is present and to continually use irrigation while the probe is active. The OSCAR bone cutting probes can greatly assist in the conservation of bone. By being a space creating tool, no wedging or forcing is needed; leading to less stress to the surrounding bone. With OSCAR, no levering motion is needed nor should be used, as levering can lead to more bone loss than desired.

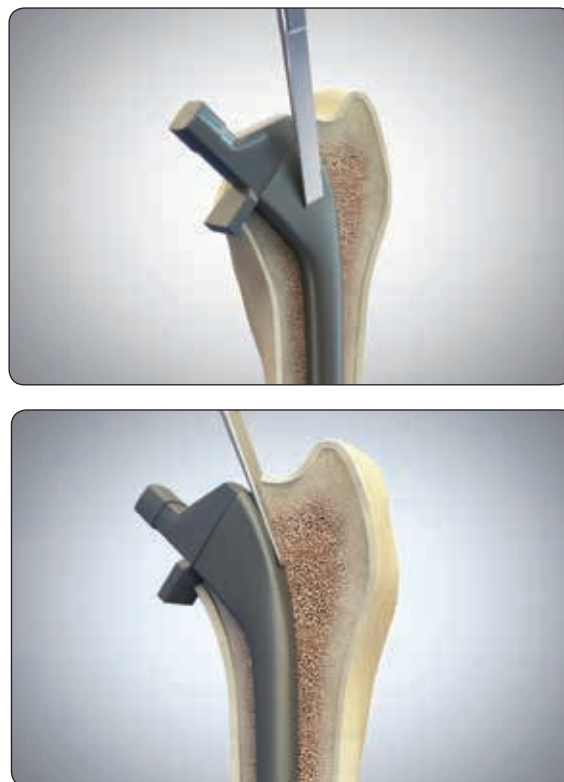

Figure 32 - Stem removal from femur

PROBLEMS & SOLUTIONS

Probe Stuck in Cement

This is most likely to occur when a piercer is being used. If the tip of the piercer is pushed too deeply into the cement and allowed to remain in situ, then the cement behind the tip is liable to solidify and trap the probe. If this happens, the load on the probe may be excessive preventing normal resonance because of the mass of cement now attached to the probe. If this occurs the generator will automatically enter a 'stuck in cement' mode and display

CEMENT RELEASE MODE

Energise the handset, but do not apply any pressure on the handset for the first 2 seconds of use (this gives the channel a better chance to find a resonant feature). The generator will perform repeated scans of the handset, sounding a double beep as it does so. Whilst this occurs, gently remove the probe from the cement. When free from cement the channel mode will return to normal operation. If the display shows

WAIT - REDUCE PRESSURE

just wait for 4 seconds and the module will reset automatically. Again, energise handset but apply little pressure on the handset for the first two seconds of use, then slowly remove probe.

This procedure may lead to an **OVER-TEMPERATURE** message on the LCD. Allow the channel to cool for several minutes. When the channel resets attempt removal again. This process may take a couple of attempts, depending how deep the probe is stuck in the cement.

Metal Fatigue

This can occur if the probe comes into contact with metal and becomes scratched, causing a stress riser to appear. When this happens, fragments of the probe are at risk of coming off during operation.

Solution: Change the probe and replace at the earliest opportunity.

Intermittent Power During Operation

If the handset/probe suffers from intermittent power and a clicking noise, caused by the tripping of relays, coming from the generator, then the cable connecting the handset to the generator will have fractured.

Solution: Change the cable associated with the defective system.

Low Power During Operation

- i. The probe will appear to be working inefficiently if it is pressed too hard into the cement. The generator will alert the surgeon by sounding an alarm.

Solution: Ease of pressure to enable the probe to work at maximum efficiency always press the tip gently into the cement and use gentle force:- allow the ultrasound to do the work. Avoid excessive force at all times.

- ii. Lack of power during cutting can be due to the interface between the probe and the handset being slack.

Solution: Tighten the connection using the 9mm spanner provided. The power level can also be diminished if this interface is not clean and has been damaged due to the presence of particles. Should this occur, it is necessary to re surface the interface, which can be done by Orthofix Srl. Should the stud attached to the probe become loose, it must be returned to Orthofix Srl for repair.

- iii. Loss of power when cutting cement can also be due to the crystals in the handset overheating. The crystals will heat up naturally during normal use, but if excessive force is used for prolonged periods of time this heating will affect performance. As the handset warms up its resonant frequency will drop. If the handset becomes too warm the frequency will drop out of the handsets' working range and the channel will shut down. The LCD will display **FREQUENCY TOO LOW**

Solution: Use another handset and allow the hot handset to cool down. The channel will reset automatically when the handset is cool.



Manufactured by:
ORTHOFIX Srl
Via Delle Nazioni 9, 37012 Bussolengo (Verona), Italy
Telephone +39 045 6719000, Fax +39 045 6719380



Distributed by:

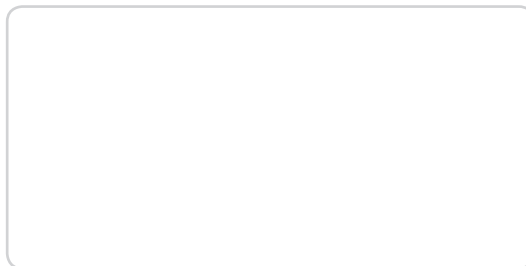

OSCAR has been designed and built in accordance with ISO 13485:2003 Quality Assurance standard for medical devices and Part 820 of the Title 21 of the Code of Federal Regulations of the USA. CE conformance has been certified and the equipment complies with BSEN60601-1.