



## **GALAXY UNYCO™ ANKLE BRIDGING**

- **DELTA FRAME**
- **UNILATERAL FRAME**

### **KEY CONTRIBUTORS:**

**S. NAYAGAM, MD**

**T. BÉGUÉ, MD**

**H.C. PAPE, MD**

**M. MANCA, MD**

## CONTENTS

---

<b>INTRODUCTION</b>	<b>3</b>
<b>GALAXY UNYCO ANKLE DELTA APPROACH</b>	<b>4</b>
<b>GALAXY UNYCO ANKLE UNILATERAL APPROACH</b>	<b>12</b>

Orthofix wishes to thank  
the following surgeons for their contribution  
to the development of the technique:

S. Nayagam, MD  
T. Bégué, MD  
H.C. Pape, MD  
M. Manca, MD

## INTRODUCTION

Rapid skeletal stabilisation with external fixation is used for some severe high energy tibial fractures, especially in those with multiple injuries or from combat or natural disaster scenarios.

This damage control surgery is part of a staged protocol where the temporary external fixation is an emergency procedure to be followed by definitive fracture fixation when conditions allow. In these scenarios, the external fixator has to be stable, versatile and quick to apply.

Ankle fractures are often associated with soft tissue injuries and their treatment should aim to restore joint congruency, mechanical alignment and early joint function while minimising soft tissue damage. In these fractures, a two-staged treatment protocol with initial spanning external fixation is advisable to allow soft tissue recovery prior to definitive treatment<sup>1-5</sup>.

The Galaxy UNYCO Ankle Bridging System is highly innovative and conceived for temporary stabilization of the ankle joint with either a "Delta" or a "Unilateral" frame, achieving excellent stability but without the screws perforating the medullary canal.

The whole system offers the following unique benefits:

### For the patients:

- Reduced x-ray exposure during application
- Designed to avoid contamination of the medullary canal
- Minimally invasive
- Designed to facilitate the conversion from temporary to definitive fixation
- Rapid application times enable the potential for lifesaving objectives to be met

### For the surgeons:

- Simplified and very rapid application
- Reduced x-ray monitoring during application
- Designed to facilitate the conversion from temporary to definitive fixation
- Designed to avoid contamination of the medullary canal
- Completely compatible with the Galaxy external fixator system, thereby enabling additional injuries of the lower limb to be stabilised and linked to the Galaxy UNYCO assembly
- Simplicity in application enabling rapid familiarity and mastery of the system

### For the hospital:

- Reduced time in the OR with potential cost savings
- Prepacked sterile kits enabling efficient inventory management, better traceability and reduced logistic costs

## References

1. Calori G, Tagliabue L, Mazza E, de Bellis U, Pierannunzi L, Marelli B, Colombo M, Albisetti W (2010) Tibial pilon fractures: which method of treatment? *Injury* 41(11):1183–1190
2. Tarkin I, Clare M, Marcantonio A, Pape H (2008) An update on the management of high-energy pilon fractures. *Injury* 39(2):142–154
3. Patterson MJ, Cole JD (1999) Two-staged delayed open reduction and internal fixation of severe pilon fractures. *J Orthop Trauma* 13(2):85–91
4. Rommens P, Claes P, Broos P (1996) Therapeutic strategy in pilon fractures type C2 and C3: soft tissue damage changes treatment protocol. *Acta Chir Belg* 96(2):85–92
5. Tornetta P III, Weiner L, Bergman M, Watnik N, Steuer J, Kelley M, Yang E (1993) Pilon fractures: treatment with combined internal and external fixation. *J Orthop Trauma* 7(6):489–496

## INTENDED USE

The Galaxy UNYCO System is intended to be used for temporary bone stabilization in trauma and orthopedic procedures of the lower limb prior to definitive treatment.

## INDICATIONS

Temporary stabilization of the tibia and foot in conditions and procedures, such as:

- Comminuted open or closed tibial fractures
- Polytrauma patient
- Damage control orthopedics for fractures with severe soft tissue injuries
- Peri-prosthetic or peri-implant fractures
- Joint dislocations, intra- and extra-articular injuries where spanning fixation is needed
- Intra-operative fracture reduction
- Intermediate stabilization in staged surgery
- Infected non-union pending second stage treatment, bone-loss or other reconstructive procedures

The Galaxy UNYCO System is compatible with Galaxy Fixation System and bicortical screws. Galaxy Fixation System and bicortical screws must be used when Galaxy UNYCO is not indicated or available.

The product is indicated for non-weight-bearing use.

## 1. GALAXY UNYCO ANKLE DELTA APPROACH

Part#	Description	Qty
99-93793	Galaxy UNYCO Ankle Bridging Box - Delta Frame	1
can accommodate:		
99-93574	Galaxy UNYCO Mini Kit Tibia Sterile	1
99-92080	Transfixing Pin Sterile 4mm	1
99-932350	Rod D12mm L 350mm Sterile	2
99-93030	Transitional Clamp Sterile	2
99-93010	Large Single Clamp Sterile	1
99-93509	Galaxy UNYCO Mini Kit Instruments Sterile	1

Out of Kit - available upon request:		
99-93010	Large Single Clamp Sterile	2
99-932200	Rod D12mm L 200mm Sterile	1
99-93570	Galaxy UNYCO Cancellous Screw Kit Sterile	1

**NOTE:** "Galaxy UNYCO" is compatible with Galaxy Fixation components; refer to "Galaxy Fixation System" Operative Technique and Brochures for specific ordering information.



99-93574 - Galaxy UNYCO Mini Kit Tibia Sterile



99-93509 - Galaxy UNYCO Mini Kit Instruments Sterile

## Tibia and Foot Insertion

Screw insertion in the tibia is within the safe corridors illustrated in the cross-sections. The anteroposterior screw is inserted lateral to the crest of the tibia (Fig. 1); screw insertion through the crest carries the risk of thermal necrosis during drilling due to the thickness of this part of the tibia and is not recommended. It is important to dissect bluntly to avoid entrapment of tibialis anterior muscle or tendon. Screws should be inserted as perpendicular to the bone surface as possible.

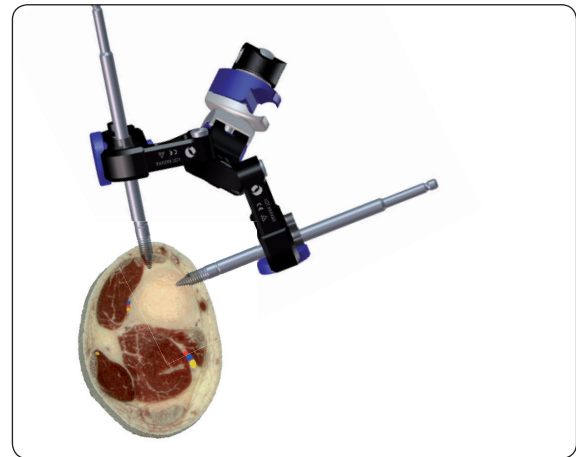
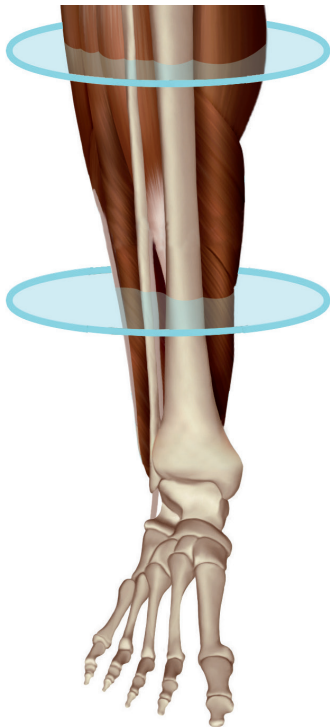

Fig. 1

**NOTE:** Support the limb with a folded towel or drape in order to facilitate better access to the limb and for fracture reduction. Always ensure limb rotation is corrected as well as angular malalignment and translation.

Insert the 4mm transfixing screw in the calcaneum ensuring the entry point is away from the posterior tibial artery and nerve. The insertion can be done using a hand or power drill.

(Fig. 2)

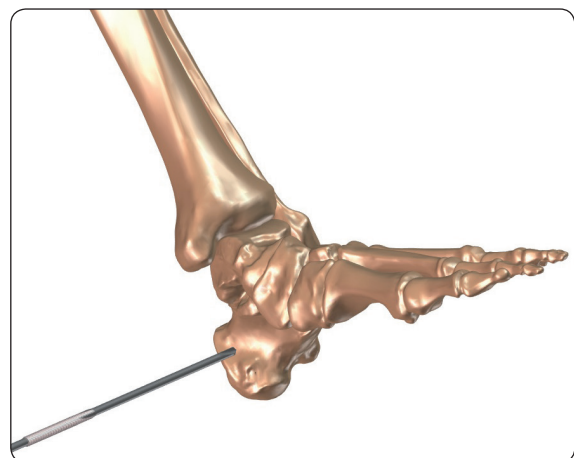

Fig. 2

Attach a Transition Clamp (99-93030) on the transfixing screw.  
(Fig. 3)

**NOTE:** Transfixing Pins shaft Ø 6mm, thread Ø7 mm, are also available single sterile packed (99-93050 and 99-93080). These should be used in conjunction with two Galaxy Large Single Clamps (99-93010).

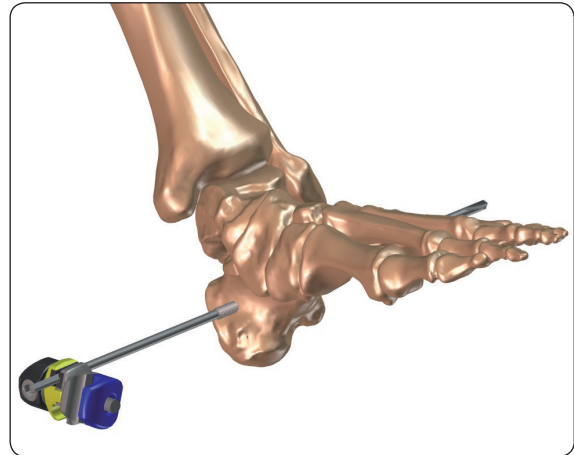

Fig. 3

Connect the Rod (350mm) to the Transition Clamp (99-93030).

Attach the Large Multiscrew Clamp for UNYCO Screws to the proximal part of the Rod.

**NOTE:** Ensure there is a sufficient length of Rod on either side of both proximal and distal clamps so as to enable reduction manoeuvres which may require distraction (lengthening) between the two clamps.

Mark the position of the Large Multiscrew Clamp for UNYCO Screws on the skin.  
(Fig. 4)

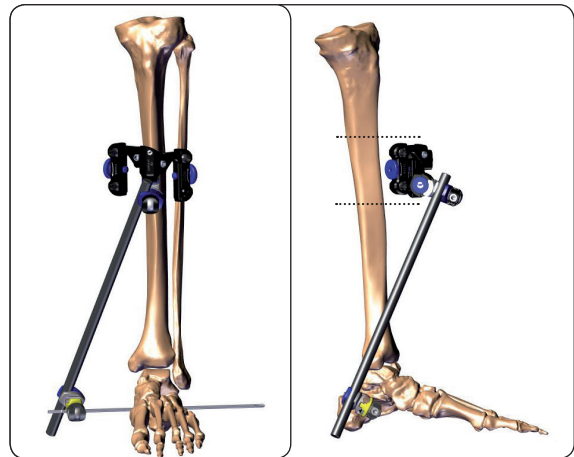

Fig. 4

Assemble the Power Drill Torque Limiter (Check the axis and movement). (Fig. 5)

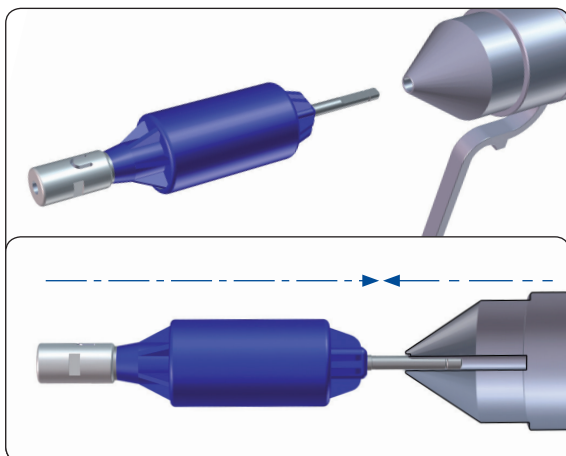
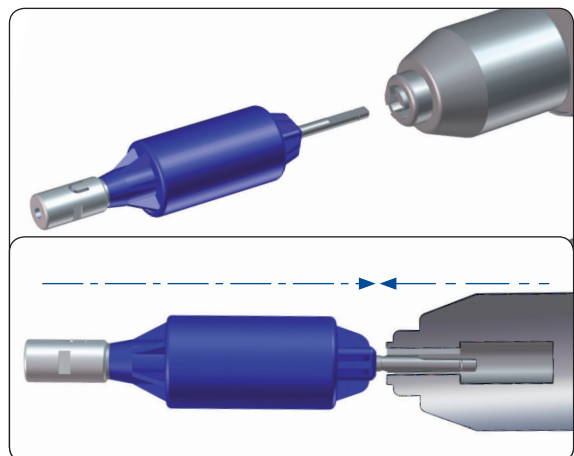

Fig. 5 With Quick Connection system



Without Quick Connection system (complete insertion into the cylindrical part)



Insert the UNYCO Cancellous Screw on the Power Drill Torque Limiter.  
(Fig. 6)

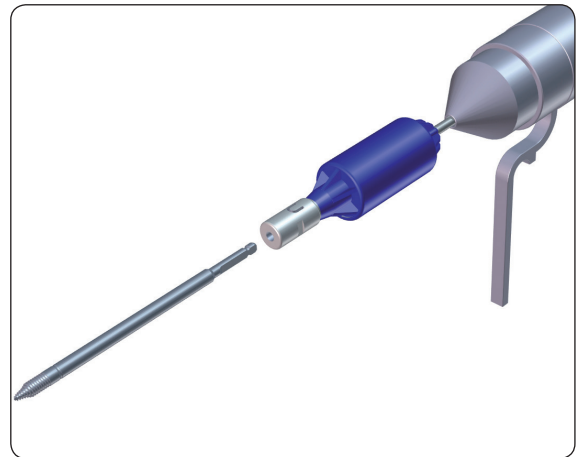

Fig. 6

Perform a small incision with scalpel on the anterior aspect of the tibia, slightly lateral to the tibial crest.

Bluntly separate tibialis anterior muscle or tendon from the lateral edge of the tibia crest.

Apply the UNYCO Cancellous Screw firmly against the bone and hold the screw perpendicular to the bone surface.

Advance the screw using the power drill lowest speed.

The depth of screw penetration will be controlled by the Power Drill Torque Limiter. When this depth has been reached, hold the screw firmly and pull off the Power Drill Torque Limiter.

It is important not to toggle the screw against bone once insertion depth has been reached.

(Fig. 7)

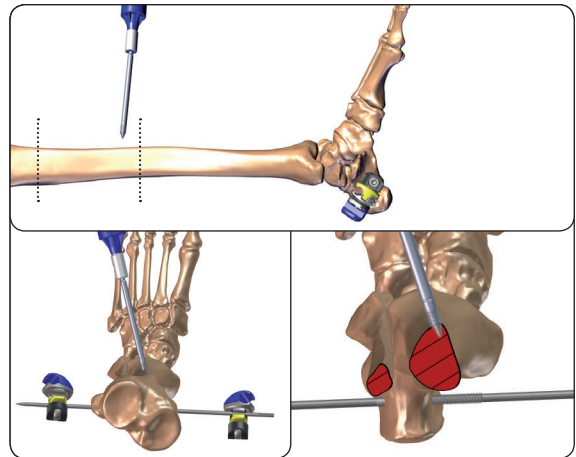

Fig. 7

Apply the Large Multiscrew Clamp for UNYCO Screws over the first screw.

Leave approximately 4cm of clearance between the clamp and the tibia.

Check the position of the medial screw to determine the best distance of the clamp from the skin.

**NOTE:** The medial screw must be perpendicular to the surface of the bone.

(Fig. 8)

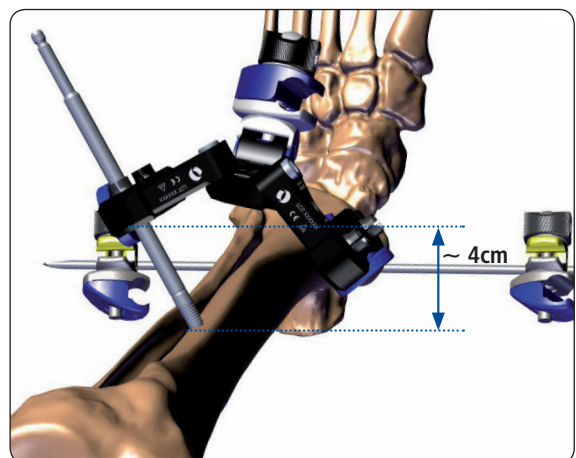

Fig. 8

Before advancing the second screw, close the blue bolt on the side of the first screw by hand so that the clamp will be supported by the first screw. At this stage, do not overtighten the blue bolt. (Fig. 9)

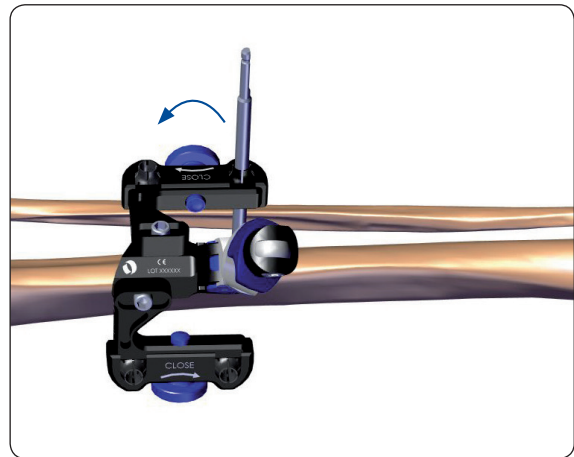

Fig. 9

Insert the second UNYCO Cancellous screw into the medial aspect of the tibia by using the clamp as a template.

It may be necessary to loosen the first blue bolt slightly to allow sufficient freedom of movement for inserting this second screw in an optimum position. (Fig. 10)

**NOTE:** The medial screw must be perpendicular to the bone.

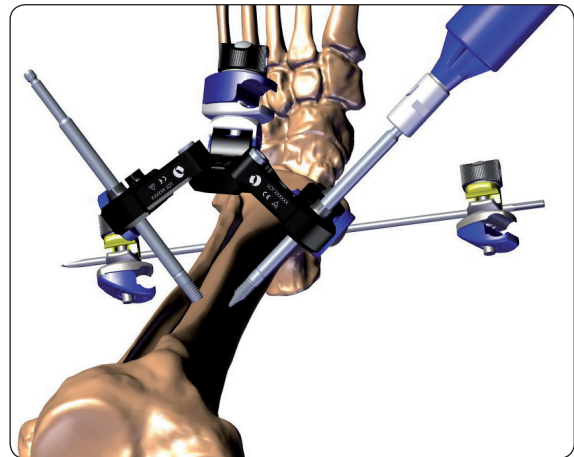

Fig. 10

Once the second screw is inserted to the correct depth, close the second (medial) blue bolt by hand. (Fig. 11)

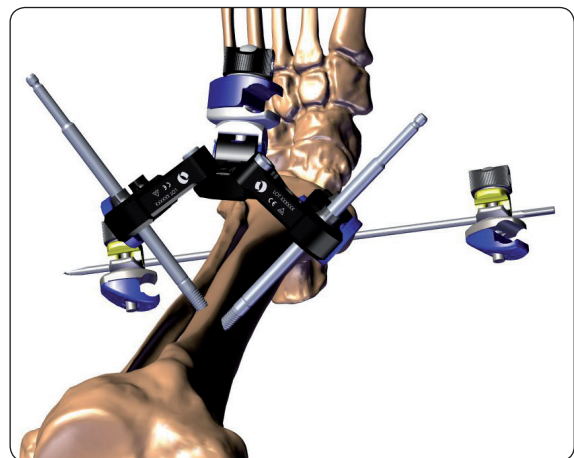

Fig. 11



**IMPORTANT:** The clamp should not be pulled/pushed after the second screw is inserted.  
(Fig. 12)

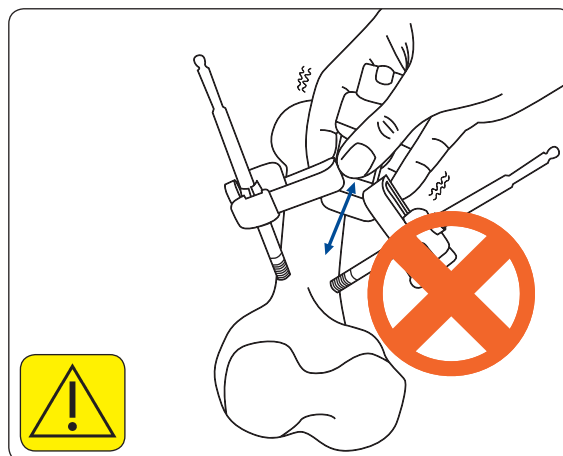

Fig. 12

Insert the remaining screws in the clamp; the blue bolts (1-2) may be loosened slightly if some additional freedom of movement is needed in positioning the remaining screws.  
(Fig. 13)

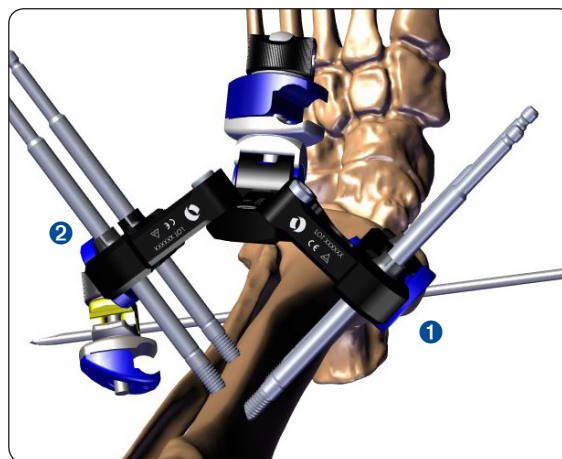

Fig. 13

Finally, close the medial and lateral blue bolts with the 5mm wrench.  
(Fig. 14)

**IMPORTANT:** Ensure both blue bolts are tightened FIRMLY after all screws are inserted.

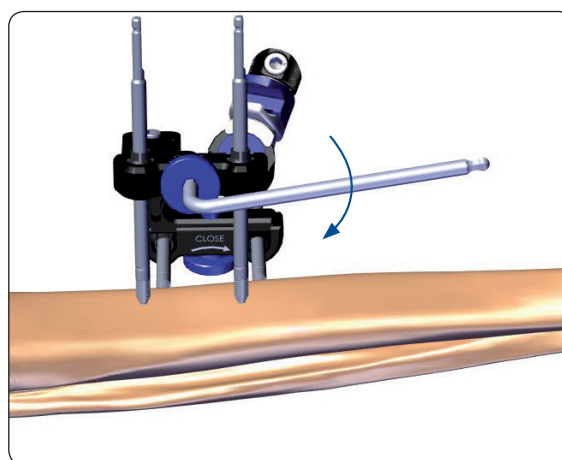

Fig. 14

Connect the Large Multiscrew Clamp for UNYCO Screws and Transition Clamps (99-93030) with the Rod and close the clamps by hand. (Fig. 15)

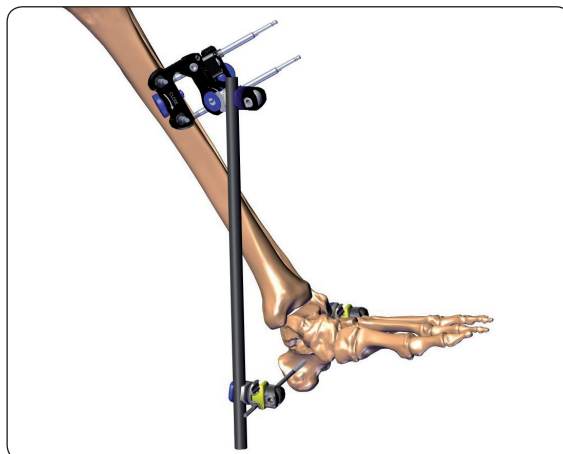

Fig. 15

Attach a large Galaxy (blue) clamp to the Rod. Connect this clamp (1) to a second (lateral) Transition Clamp (99-93030) (2) using a second Rod. (Fig. 16)

**NOTE:** Never attach Rods to the uni-cortical screw shafts in the Large Multiscrew Clamp for UNYCO Screws.

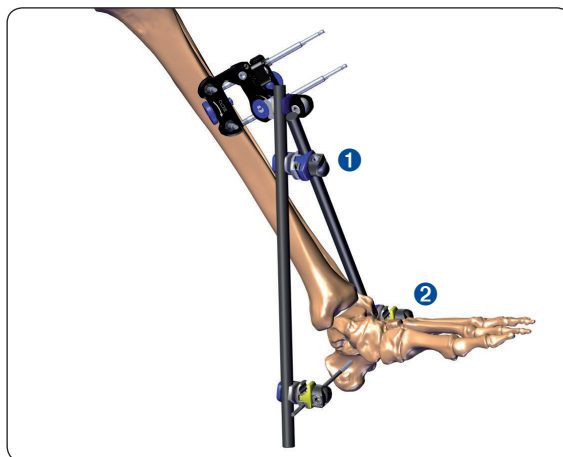

Fig. 16

Reduce the fracture and close all clamps by hand. (Fig. 17)

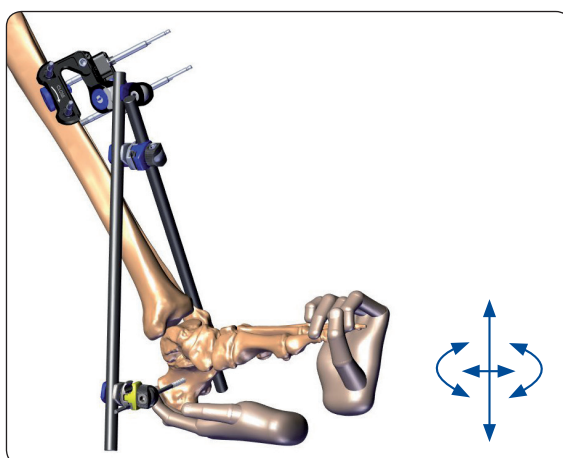
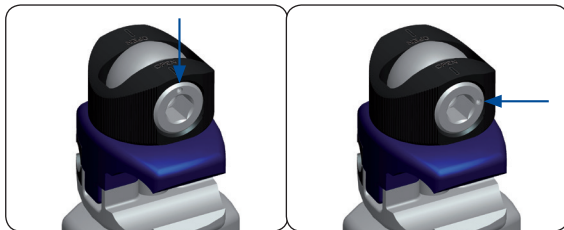

Fig. 17

Check the quality of reduction in the coronal and sagittal planes with x-rays and rotational alignment by clinical assessment before tightening all clamps finally with a 5mm Allen wrench.  
(Fig. 18)



Open

Close

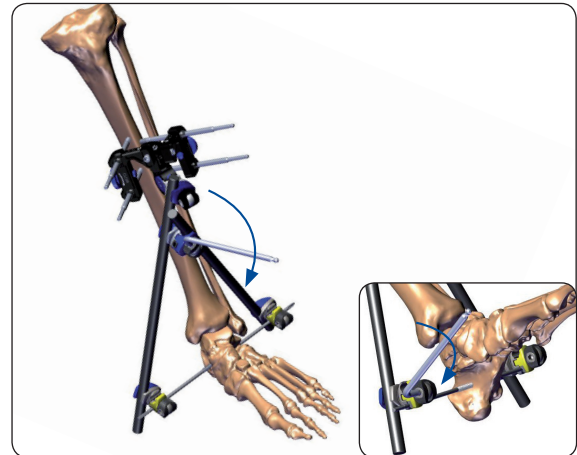

Fig. 18

If necessary to avoid equinus deformity of the foot, insert a UNYCO Cancellous Screw in the first metatarsal bone and connect it to the frame using additional Galaxy Fixation Large Clamps and Rod.  
(Fig. 19)

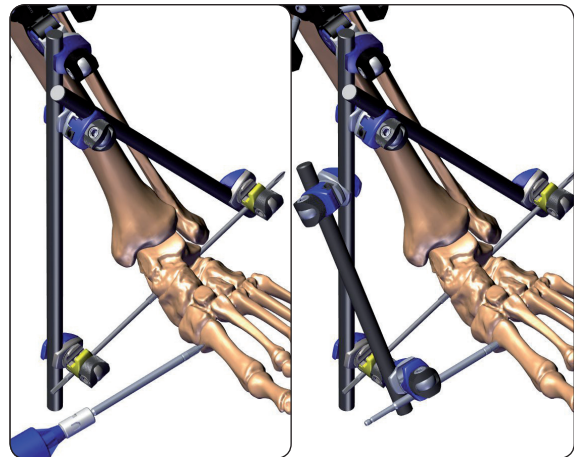

Fig. 19

#### CHANGING TO DEFINITIVE TREATMENT

Prior to the conversion surgery clean and brush the Galaxy UNYCO frame or cover the entire assembly with a sterile drape or similar to avoid contamination in the field of surgery.

## 2. GALAXY UNYCO ANKLE UNILATERAL APPROACH

Part#	Description	Qty
99-93792	Galaxy UNYCO Ankle Bridging Box - Unilateral Frame	1
can accommodate:		
99-93574	Galaxy UNYCO Mini Kit Tibia Sterile	1
99-932350	Rod D12mm L 350mm Sterile	2
99-93010	Large Single Clamp Sterile	6
99-93477	Galaxy UNYCO Mini Kit Ankle Unilateral Sterile	1
99-93509	Galaxy UNYCO Mini Kit Instruments Sterile	1



99-93574 - Galaxy UNYCO Mini Kit Tibia Sterile

**NOTE:** “Galaxy UNYCO” is compatible with Galaxy Fixation components; refer to “Galaxy Fixation System” Operative Technique and Brochures for specific ordering information.



99-93477 - Galaxy UNYCO Mini Kit Ankle Unilateral Sterile



99-93509 - Galaxy UNYCO Mini Kit Instruments Sterile

## Tibia and Foot Insertion

Screw insertion in the tibia is within the safe corridors illustrated in the cross-sections. The anteroposterior screw is inserted slightly medial (**Fig. 1**) or lateral (**Fig. 2**) to the crest of the tibia; screw insertion through the crest carries the risk of thermal necrosis during drilling due to the thickness of this part of the tibia and is not recommended. If inserted 1 centimetre lateral to the crest, it is important to dissect bluntly to avoid entrapment of tibialis anterior muscle or tendon. Screws should be inserted as perpendicular to the bone surface as possible.

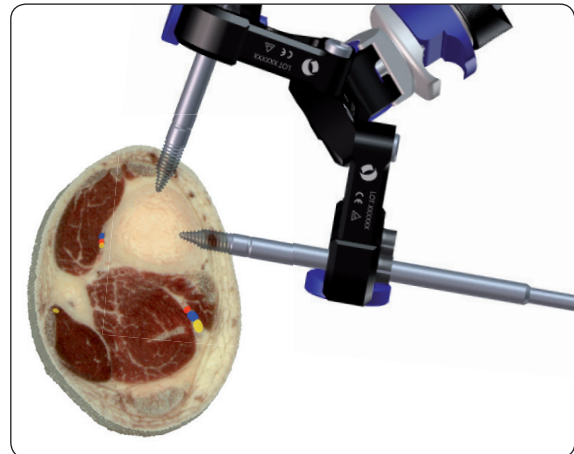
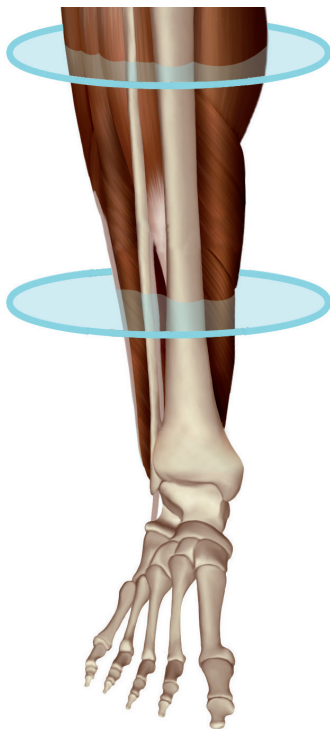

Fig. 1

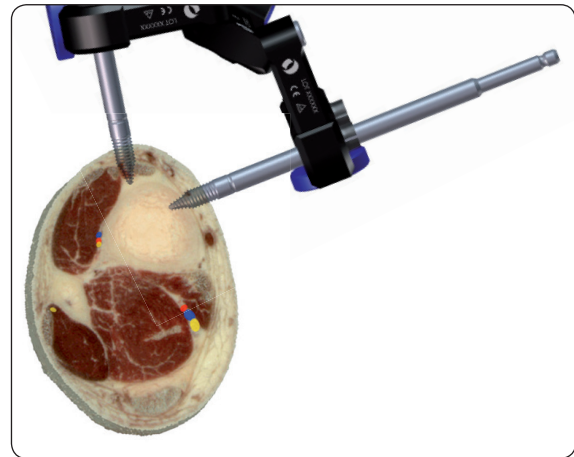

Fig. 2

In the foot, UNYCO Cancellous Screws are inserted in the following sequence:

- 1) neck of talus
- 2) calcaneum
- 3) first metatarsal

(**Fig. 3**)

It is important to insert the talar neck screw first as it has a small corridor for insertion. The other two screws have larger corridors and are easier to apply. The point of insertion is the midpoint between the anterior edge of the medial malleolus and prominence of the tuberosity of the navicular.

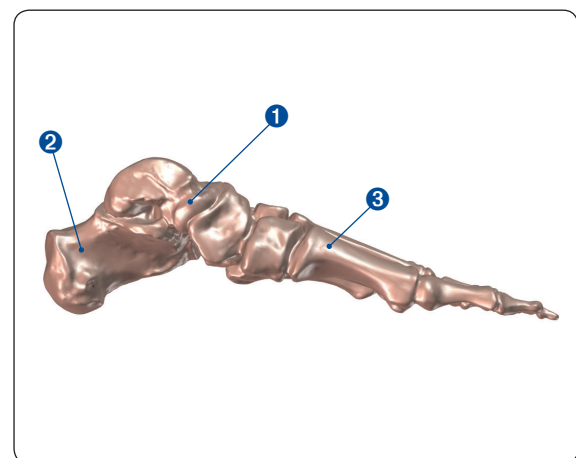

Fig. 3

Assemble the Power Drill Torque Limiter (Check the axis and movement). (Fig. 4)

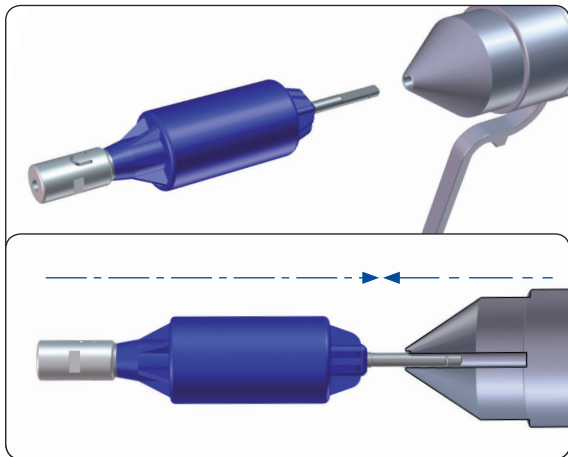
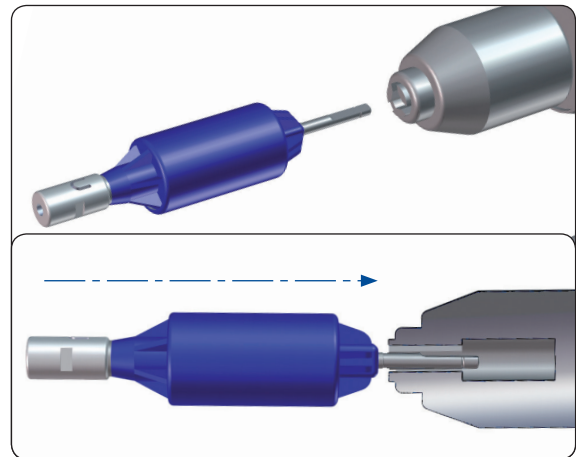

Fig. 4 With Quick Connection system



Without Quick Connection system  
(Complete insertion into the cylindrical part)

Insert the UNYCO Cancellous Screw on the Power Drill Torque Limiter. (Fig. 5)

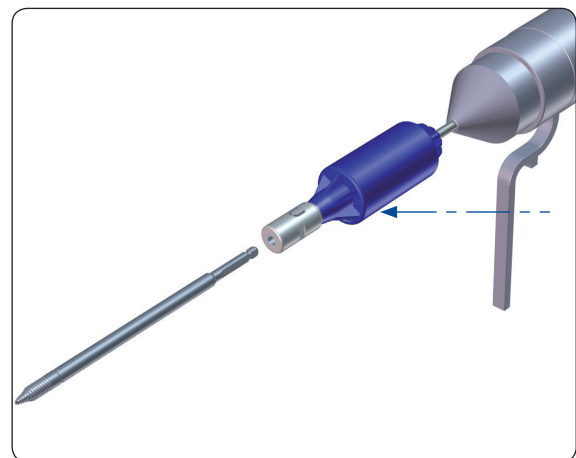

Fig. 5



Identify the midpoint between the anterior edge of the medial malleolus and prominence of the tuberosity of the navicular. Axis of the screw must be perpendicular to the plane of the foot. Perform a small incision with scalpel through skin, fascia and capsule bluntly open a track down to the neck of talus. (Fig. 6)

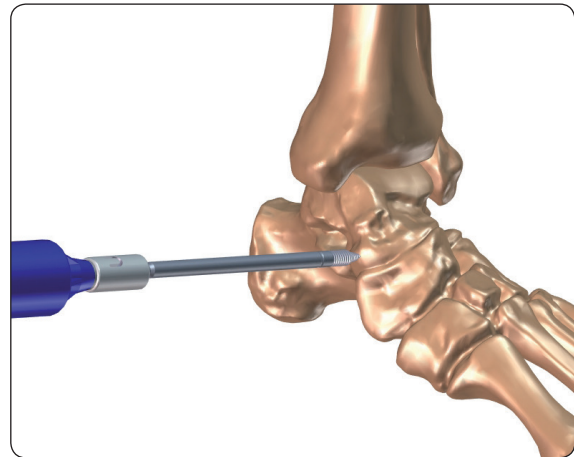

Fig. 6

Insert a UNYCO Cancellous Screw in the middle of the neck of talus either by palpation or with X-ray guidance. Use the reference line (1) on the screw if the Power Drill Torque Limiter does not engage.

**WARNING:** The Soft Tissue Reference Line on the screw must not go deeper than the skin surface. (Fig. 7)

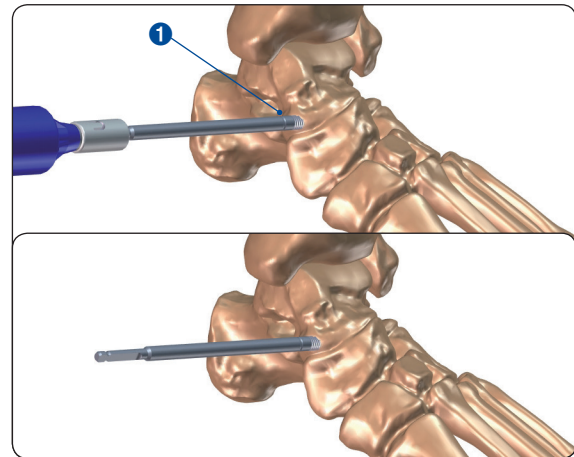

Fig. 7

Next insert a UNYCO Cancellous Screw into the calcaneum, approximately at the junction of the middle and posterior thirds of a line connecting the posterior edge of the medial malleolus and posterior aspect of calcaneum.

**WARNING:** The Reference line on the screw must not penetrate deeper than the skin surface. (Fig. 8)

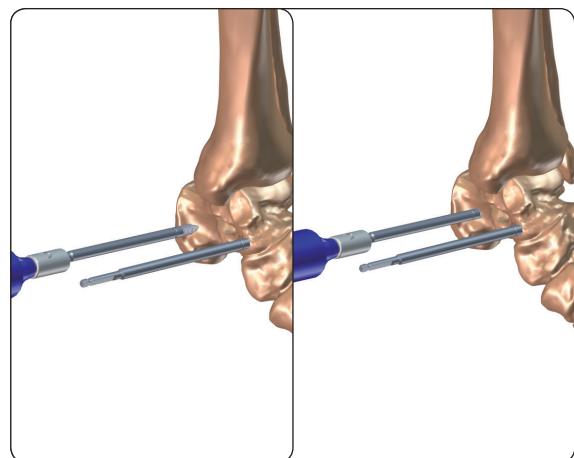

Fig. 8

Finally insert a UNYCO Cancellous Screw at the proximal meta-diaphyseal junction of the 1<sup>o</sup> metatarsal bone. All screws must be approximately parallel to the talar screw.

**WARNING:** The Soft Tissue Reference Line of the screw must not penetrate deeper than the skin surface. (Fig. 9 - Fig. 10)

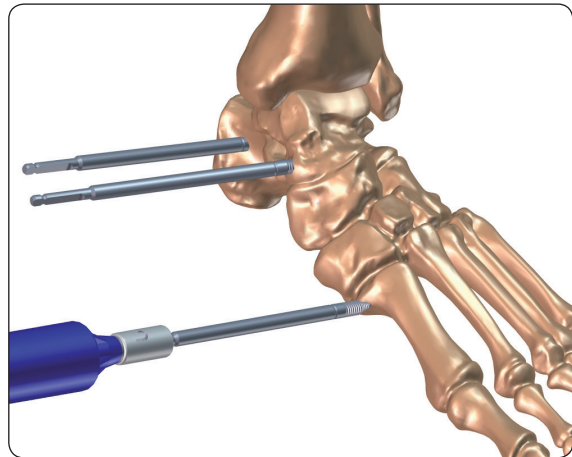

Fig. 9

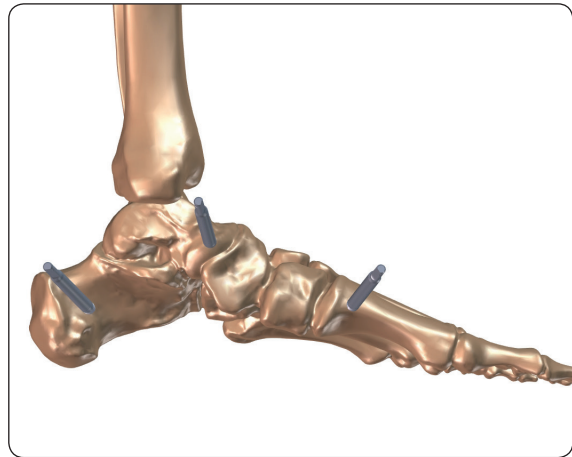

Fig. 10

Attach a Large Single Clamp Sterile (99-93010) on each UNYCO Cancellous Screw. (Fig. 11)

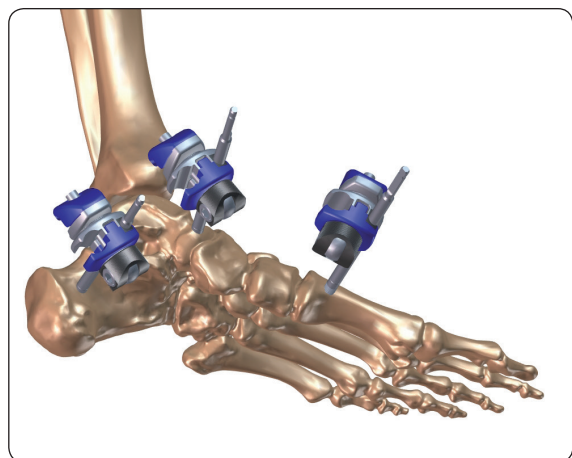

Fig. 11

Unlock the hinge of the Radiolucent Foot Unit (1).  
(Fig. 12)

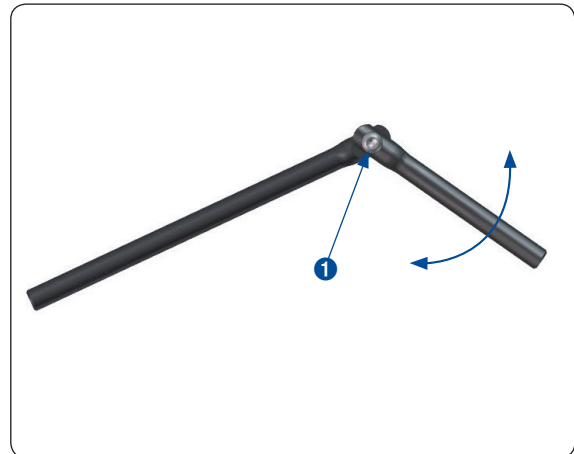

Fig. 12

Position the longer arm of the unit on the posterior part of the foot and the shorter arm anteriorly.

Connect the Radiolucent Foot Unit to the screws using Large Single Clamps Sterile (99-93010) and secure the Rod to the screws by tightening the clamps by hand initially (2).

(Fig. 13)

**NOTE:** The longer arm of the Radiolucent Foot Unit is positioned posteriorly to enable attachment of a kickstand support if this is desired.

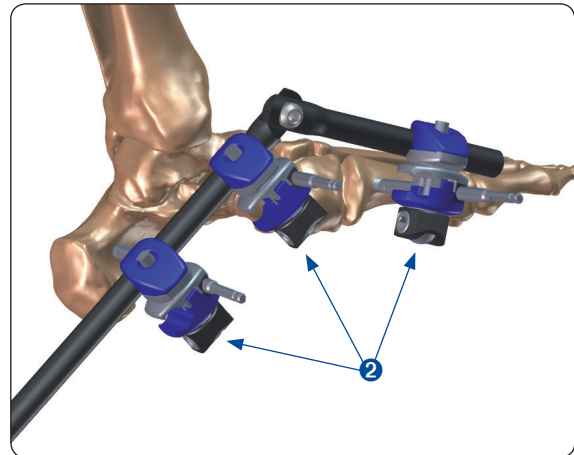
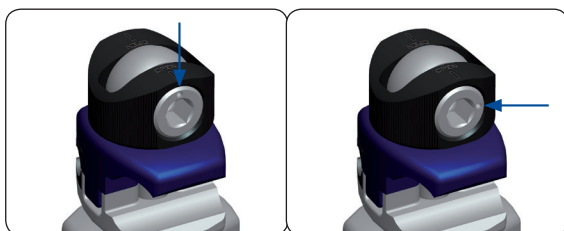

Fig. 13

Insert the wrench (30017) into the cam of each clamp and lock the clamps using the recommended technique.

(Fig. 14)



Open

Close

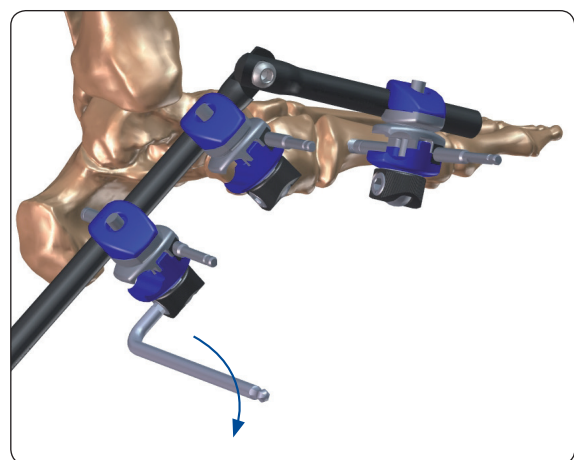

Fig. 14

In the process of clamp tightening, minimise the toggling of the UNYCO Cancellous Screw within the clamp.

Dorsiflex the forefoot into the neutral position before locking the hinge of the Radiolucent Foot Unit. (Fig. 15)

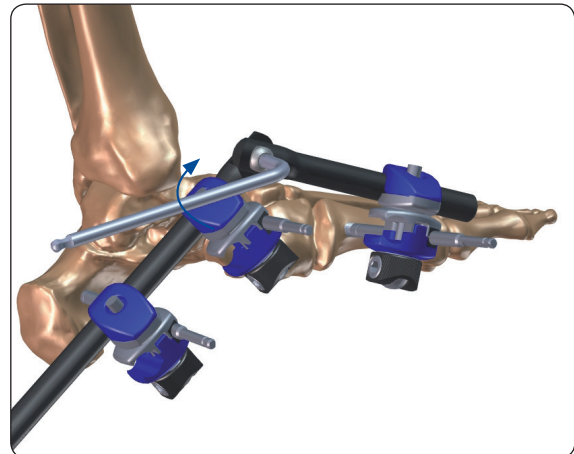

Fig. 15

The Large Multiscrew Clamp for UNYCO Screws should be applied proximal to the fracture, usually at the level of the mid-shaft of the tibia proximal or distal to this. If more proximal positioning of the clamp is required, ensure that 400 mm Rods are available for use.

**NOTE:** Ensure a length of Rod is available on either side of the two connecting clamps to allow for reduction manoeuvres.

Mark the position of the Large Multiscrew Clamp for UNYCO Screws on the skin. (Fig. 16)

**NOTE:** Support the limb with a folded towel or drape in order to facilitate better access to the limb and for fracture reduction. Always ensure limb rotation is corrected as well as angular malalignment and translation.

Perform a small incision on the anterior aspect of the tibia, approximately 5-10mm medial to the crest of the tibia.

Apply the UNYCO Cancellous Screw firmly against the bone and hold the screw perpendicular to the bone surface.

Advance the screw using the power drill at low speed.

The depth of screw penetration will be controlled by the Power Drill Torque Limiter. When this depth has been reached, hold the screw firmly and pull off the Power Drill Torque Limiter and power drill.

(Fig. 17)

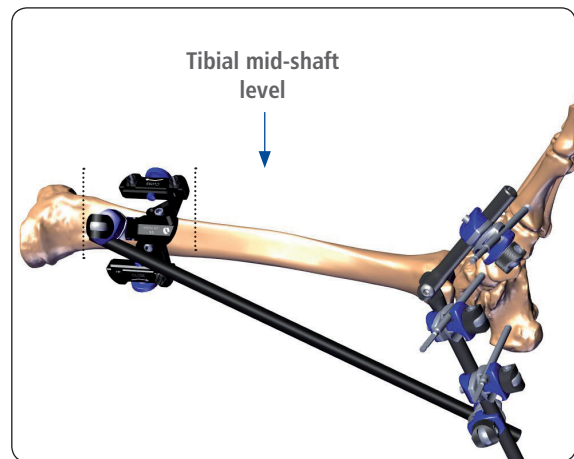

Fig. 16

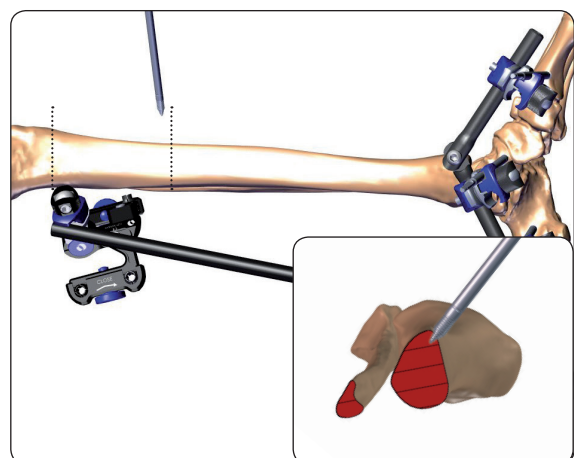

Fig. 17

It is important not to bend or toggle the screws after insertion.  
(Fig. 18)

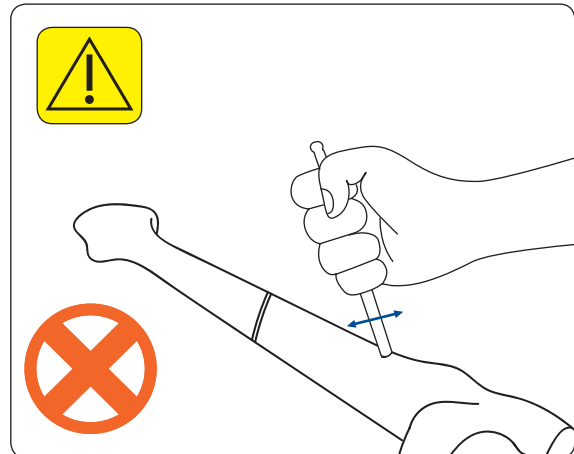

Fig. 18

Apply the Large Multiscrew Clamp for UNYCO Screws over the first screw.

Leave approximately 4cm of clearance between the clamp and the tibia.

Check the position of the medial screw (second screw to be inserted) to determine the best distance of the clamp from the skin.  
(Fig. 19)

**NOTE:** The medial screw must be as perpendicular as possible to the bone.

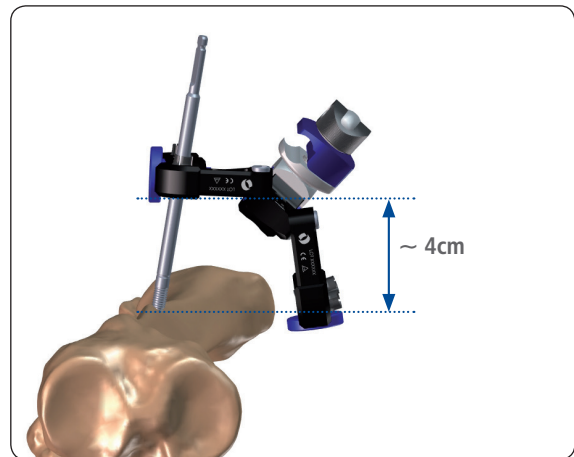

Fig. 19

Close the blue bolt by hand so that the clamp will be supported by the first screw. At this stage, do not overtighten the blue bolt.  
(Fig. 20)

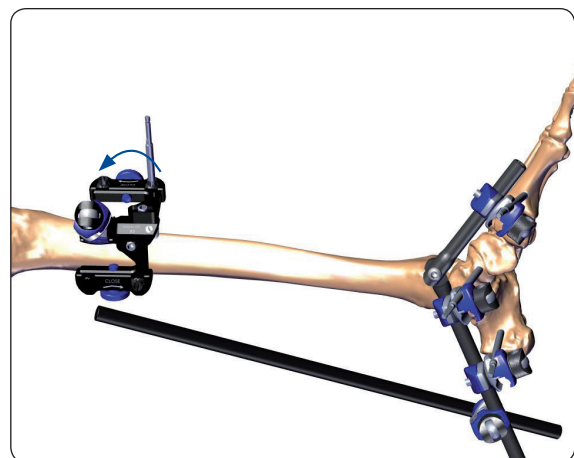

Fig. 20

Insert the second UNYCO Cancellous Screw into the medial surface of the tibia. Use the clamp as a template guide.

It may be necessary to loosen the first blue bolt slightly to allow sufficient freedom of movement for inserting this second screw in an optimum position.  
(Fig. 21)

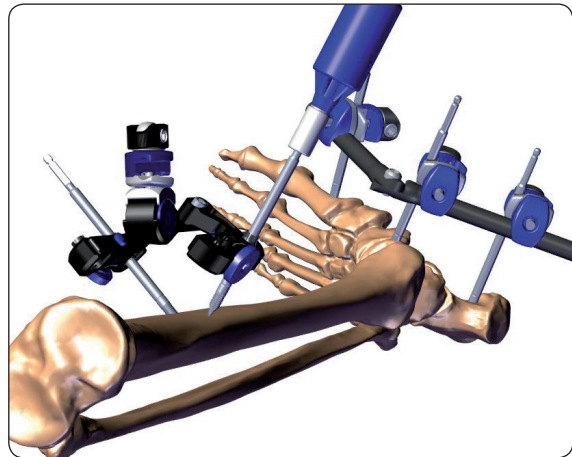

Fig. 21

Once the second screw is inserted to the correct depth, close the second (medial) blue bolt by hand.

(Fig. 22)

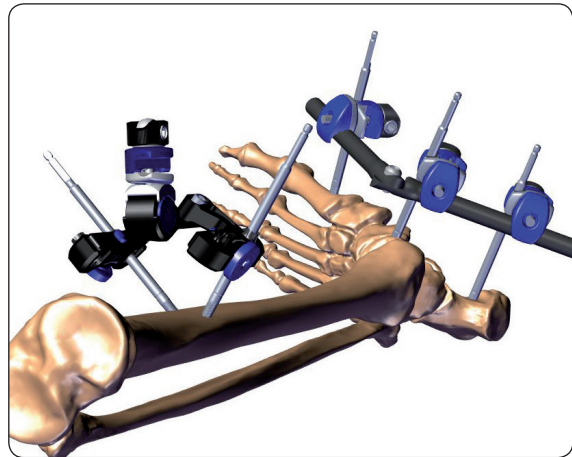

Fig. 22

**IMPORTANT** - The clamp should not be pulled/pushed after the second screw is inserted.  
(Fig. 23)

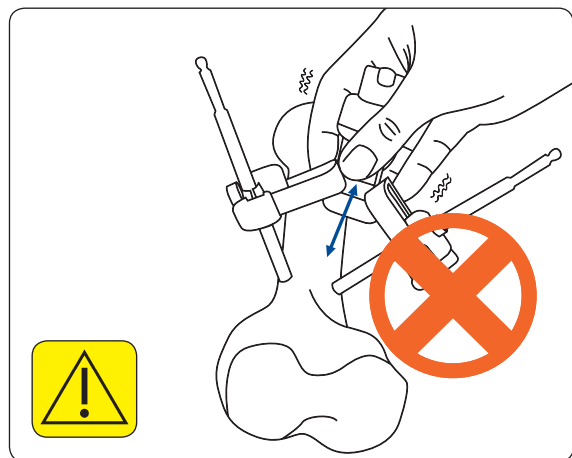

Fig. 23



Insert the remaining 2 screws; the blue bolts may be loosened slightly if some additional freedom of movement is needed in positioning the remaining screws.  
(Fig. 24)

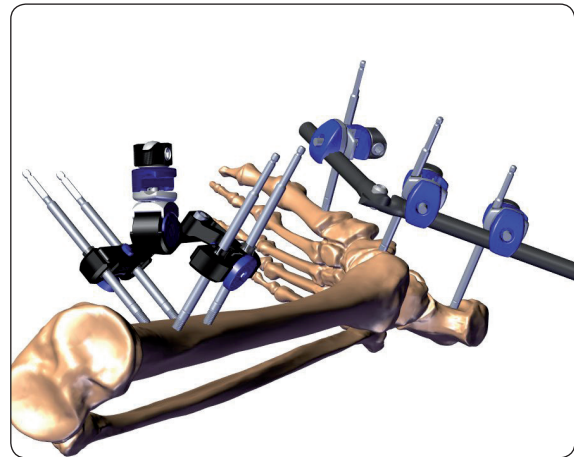

Fig. 24

Finally, close the medial and lateral blue bolts with the 5mm wrench (1-2).  
(Fig. 25)

**IMPORTANT:** Ensure that both blue bolts are tightened FIRMLY after all screws are inserted.

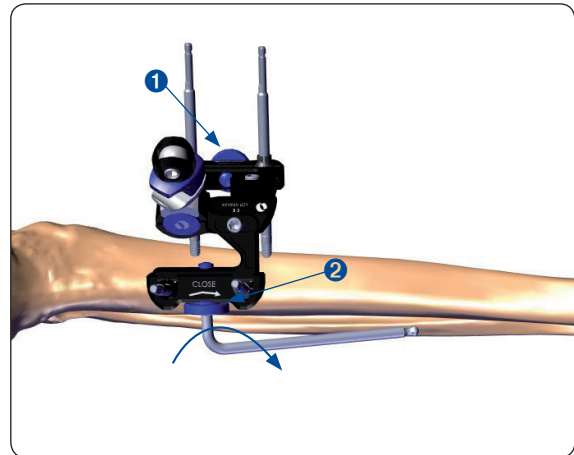

Fig. 25

Connect a 350mm straight Rod to the Large Multiscrew Clamp for UNYCO Screws on the tibia.

Connect this Rod to the long arm of the Radiolucent Foot Unit using a Large Single Clamp Sterile (99-93010).

Place the ankle in the plantigrade position and tighten the clamp by hand to hold the ankle in this position.  
(Fig. 26)

**NOTE:** Leave a length of the Rod protruding from the clamps to allow for reduction manoeuvres.

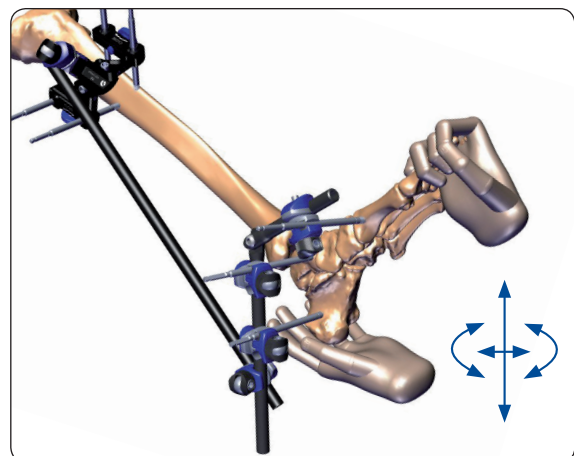

Fig. 26

Finally, complete the 'delta' construct by connecting the proximal end of the tibial Rod with the shorter arm of the Radiolucent Foot Unit using a 350mm Rod. Ensure that the calcaneum is held in valgus before finally tightening the clamps.

Ensure all clamps are tightened as firmly as possible by hand.

Check the quality of reduction in the coronal and sagittal planes with x-rays and rotational alignment by clinical assessment before tightening all clamps finally with a 5mm Allen wrench.

(Fig. 27)

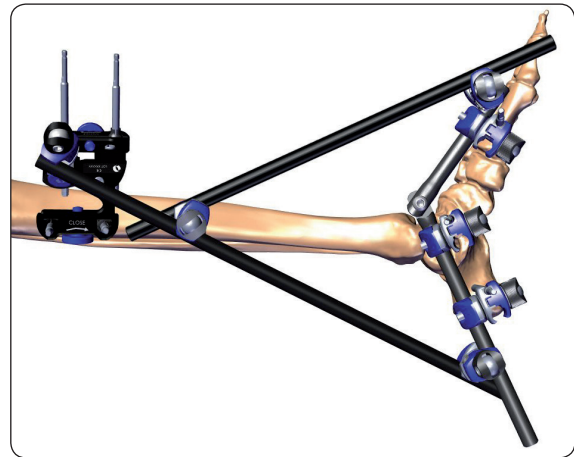

Fig. 27

To enable elevation of the foot and ankle, a kickstand construct can be added to the posterior end of the longer arm of the Radiolucent Foot Unit.

Use a Large Single Clamp Sterile (99-93010) to attach an additional Rod perpendicular to the long arm. Tighten the clamp securely to prevent rotation of the Rods.

(Fig. 28)

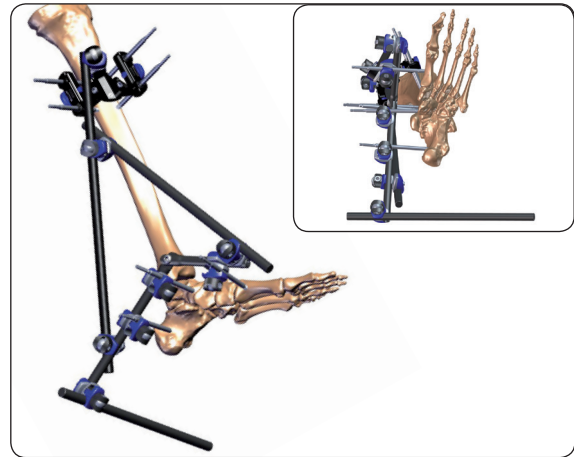

Fig. 28

#### CHANGING TO DEFINITIVE TREATMENT

Prior to the conversion surgery clean and brush the Galaxy UNYCO frame or cover the entire assembly with a sterile drape or similar to avoid contamination in the field of surgery.





Manufactured by:  
ORTHOFIX Srl  
Via Delle Nazioni 9, 37012 Bussolengo (Verona), Italy  
Telephone +39 045 6719000, Fax +39 045 6719380



**Distributed by:**

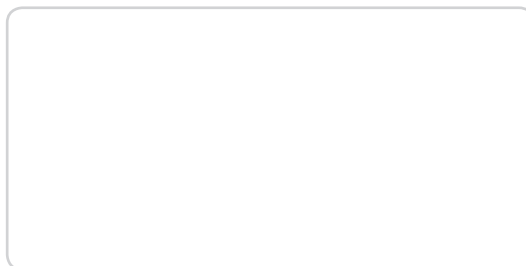

Instructions for Use: See actual package insert for Instructions for Use.

Caution: Federal law (USA) restricts this device to sale by or on the order of a physician. Proper surgical procedure is the responsibility of the medical professional. Operative techniques are furnished as an informative guideline. Each surgeon must evaluate the appropriateness of a technique based on his or her personal medical credentials and experience. Please refer to the "Instructions for Use" supplied with the product for specific information on indications for use, contraindications, warnings, precautions, adverse reactions and sterilization.

[www.orthofix.com](http://www.orthofix.com)

MC-1508-OPT-E0 A 10/15

